

METAL ROOFING

MAGAZINE

A Construction Magazine Network Brand ■ www.constructionmagnet.com

2019
CONSTRUCTION
ROLLFORMING SHOW
CINCINNATI, OH • DEC. 12-13

17TH ANNUAL

2020 BUYERS' GUIDE

100s of Products
& Services For
Metal Industry
Professionals



SEE OUR PRODUCT
PROFILES INSIDE

 **EDCO**

LELAND
INDUSTRIES INC.

**DYNAMIC
FASTENER**

**ACE
CLAMP**
Innovative Roofing Solutions™

DEC. 2019/JAN. 2020 • Volume 18, Issue 7



Superior Quality Superior Value Class A Fire Rated

Proven performance—preferred by
contractors for over 30 years.

THE ORIGINAL CUSTOM RIDGE VENT

Cut to fit **Standing Seam** and **Screw-Down** Panels in over
50 Profiles for Commercial, Agricultural,
and Residential Metal Roofs.

- 40-year limited warranty
- Glue spots prevent slipping during installation
- Fits under any ridge cap
- Class A Fire Rating—WILL NOT BURN
- One person roll-out installation
- Over one million installed—zero call backs
- Miami-Dade approved Noa No.: 17-0821.09



Also Available in
**3' Hi Rib Stick ¾" and
R Panel Sticks
2" or 3" wide.**

ProfileVent®

THE RIDGE VENT CUT TO FIT



www.profilevent.com

Toll Free 833-300-9515 • customerservice@ventcoinc.com

Editors
Sharon Thatcher
 sharon@shieldwallmedia.com
 715-257-4197

Karen Knapstein
 karen@shieldwallmedia.com
 715-598-4004

Publisher
Gary Reichert
 gary@shieldwallmedia.com
 715-252-6360

Designers
 Tom Nelsen
 Kevin Ulrich

Production Coordinator
 Kathy Budsberg
 kathy@shieldwallmedia.com

Circulation/Database Manager
 Missy Fenn
 missy@shieldwallmedia.com
 715-446-4243

Subscription Services
 subs@shieldwallmedia.com
 715-446-4243

Customer Service
 help@shieldwallmedia.com

METAL ROOFING MAGAZINE (ISSN: 1533-8711) (Volume 18, Issue 7) is published seven times annually in February, April, May, June, August, October and December by Shield Wall Media LLC, 1990 Godfrey Dr, Waupaca, WI 54981. Periodical postage paid at Iola WI, and at additional mailing offices. Canadian Agreement Number: 40665675. POSTMASTER: Send address changes to Metal Roofing Magazine, Missy Fenn, PO BOX 255, Iola WI 54945. Copyright 2019 Shield Wall Media LLC. Metal Roofing Magazine and its logo are registered trademarks. Other names and logos referred to or displayed in editorial or advertising content may be trademarked or copyright. Metal Roofing Magazine assumes no responsibility for unsolicited materials sent to it. Publisher and advertisers are not liable for typographical errors that may appear in prices or descriptions in advertisements. Mailed free to roofing contractors and their suppliers throughout North America. Others may subscribe: \$29.98 for 1 year, \$56.98 for 2 years, and \$80.98 for 3 years.



CONTENTS

17TH ANNUAL BUYERS' GUIDE

4: Product Guide

Metal Roofing Suppliers and Manufacturers Listed by Product

14: 2020 Company Directory

Alphabetical listing of companies that offer products and services in the metal roofing industry

Product Profiles

25: Table of Contents

26: Coil & Coil Coatings

27: Equipment & Jobsite Tools

30: Fasteners & Sealants

32: Insulation

33: Retrofit & Recoatings

34: Roofing Components

37: Roofing Panel

40: Underlayment

41: Ventilation

43: Comparison of Retrofit Systems Over Existing Metal Roofs

White paper from the MBMA comparing two commonly used methods



39



27

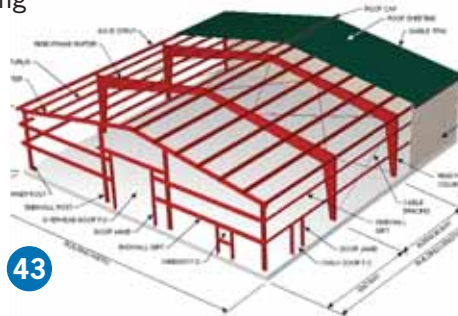

43

DEPARTMENTS

- 42 Ad Index
- 42 Classifieds
- 52 Industry News
- 54 Project of the Month

On the Cover: Main photo, from Project of the Month, courtesy of Graber Post Buildings; Cupola, Plyco Corp.; Roll-forming machine, ASC Machine Tools, Inc.. Design by Kevin Ulrich

ONLINE SERVICES:

- Metal Roofing Buyers' Guide
- Subscribe FREE to Metal Roofing Magazine
- Archived Stories
- Metal Roofing Hall of Fame
- Subscribe to *RooferExpress* newsletter



CHECK OUT OUR WEBSITE @
www.constructionmagnet.com

E-MAIL THE EDITOR AT
 sharon@shieldwallmedia.com

PRODUCT GUIDE

Your comprehensive source for products and services in the metal roofing industry.

HOW TO USE THIS RESOURCE:

The index below is a guide to help you find companies, suppliers, manufacturers, and associations that provide specific products or services for the metal roofing industry. This index is followed by an alphabetical listing. Many companies have included logos and/or descriptions of their businesses to explain their offerings. Companies that have won the 2019 Metal of Honor Awards are marked with Metals of

Honor. Companies that advertised separately in this issue can be found in our ad index on page 42. As an added convenience, the Buyers' Guide is also available online at www.constructionmagnet.com, the Construction Magazine Network. The online version contains a more comprehensive list of suppliers for each category.



PRODUCT CATEGORIES

COIL COATING (PAINT) SYSTEMS

AkzoNobel
Arkema, Inc.
Becker Specialty Corp.
Dura Coat Products
Kynar Aquatec
Liberty Steel Products
Prassas Metal Products
Sherwin-Williams Coil Coatings
United Steel Supply

COIL/SHEET DISTRIBUTORS (BY SUBSTRATE)

ALUMINIUM

ABC Supply Co.
Everlast Metals
Everlast Roofing
Fabral
Isaiah Industries, Inc.
Petersen Aluminum
Wrisco Industries Inc.

COPPER

Fabral

GALVANIZED AND GALVALUME

CertainTeed
Everlast Metals
Everlast Roofing
Fabral
Liberty Steel Products
Prassas Metal Products
Sheffield Metals International
United Steel Supply

STAINLESS STEEL & TITANIUM

Fabral
Petersen Aluminum

STEEL, COLD-ROLLED & WEATHERING

EDCO Products
Fabral
Liberty Steel Products
United Steel Supply

TERNE

Fabral

ZINC

Fabral
Prassas Metal Products
Sheffield Metals International

CLAD PRODUCTS

Fabral
Prassas Metal Products
Wrisco Industries Inc.

INSULATION

BATT & FORM BOARD

East Coast Fasteners
Filc USA - DR!PSTOP
Metal Panels, Inc.
NOFP, Inc.
Ramco Supply
Southern Tool and Supply

REFLECTIVE INSULATION

Covertch - rFoil Insulation
East Coast Fasteners
MWI Components
Nationwide Protective Coating Mfrs.
NOFP, Inc.
Reflective Insulation Manufacturers Association-International

METAL ROOFING COMPONENTS

CLIPS, STANDING SEAM

American Building Components

ABC Supply Co.
BECK America
Building Products Development
Day Glow Inc.
Dynamic Fastener
East Coast Fasteners
EDCO Products
Englert Inc.
Leland Industries
Marco Industries
Metal Panels, Inc.
Morin Corp, Kingspan
MWI Components
Petersen Aluminum
SFS
Sheffield Metals International
Snap-Z, Glick Metals
ST Fastening Systems
Triangle Fastener

CLOSURE STRIPS

American Building Components
Dynamic Fastener
East Coast Fasteners
Filc USA - DR!PSTOP
Leland Industries
Levi's Building Components
Marco Industries
MWI Components
SFS
Snap-Z, Glick Metals
ST Fastening Systems
Ventco

CURBS & HATCHES

East Coast Fasteners
Southern Tool and Supply

FASTENERS, STANDING SEAM

AceClamp

Atlas Bolt & Screw
BECK America
Dynamic Fastener
East Coast Fasteners
Grabber Post Buildings
Leland Industries
Levi's Building Components
Petersen Aluminum
S-5! Attachment Solutions
SFS
ST Fastening Systems
Triangle Fastener

FASTENERS

ABC Supply Co.
Atlas Bolt & Screw
BECK America
Day Glow Inc.
Dynamic Fastener
East Coast Fasteners
Englert Inc.
Grabber Post Buildings
Leland Industries
Levi's Building Components
Maze Nails
SFS
ST Fastening Systems
Triangle Fastener

ROOF FLASHINGS

Advanced Architectural
Atlas Bolt & Screw
Aztec Washer Co., Inc.
Dynamic Fastener
East Coast Fasteners
Fabral
GutterSupply.com
Leland Industries
Levi's Building Components
Marco Industries

DRIPSTOP
Condensation control



Increase Profits Not Labor Costs

A Necessity for Any Metal Roofed Building That is Not Climate Controlled.

- Post Frame/agricultural buildings
- Steel buildings
- Self-storage
- Workshops/unattached garages
- Open-walled structures
- Carports, truck ports & RV storage

Better Science Equals Drier Buildings

When condensation occurs, moisture gets stored in the specially designed pockets of the DripStop membrane.

- Helps fight corrosion in livestock confinement
- Arrives on-site already on roof panels
- Cuts construction time in half
- Saves money

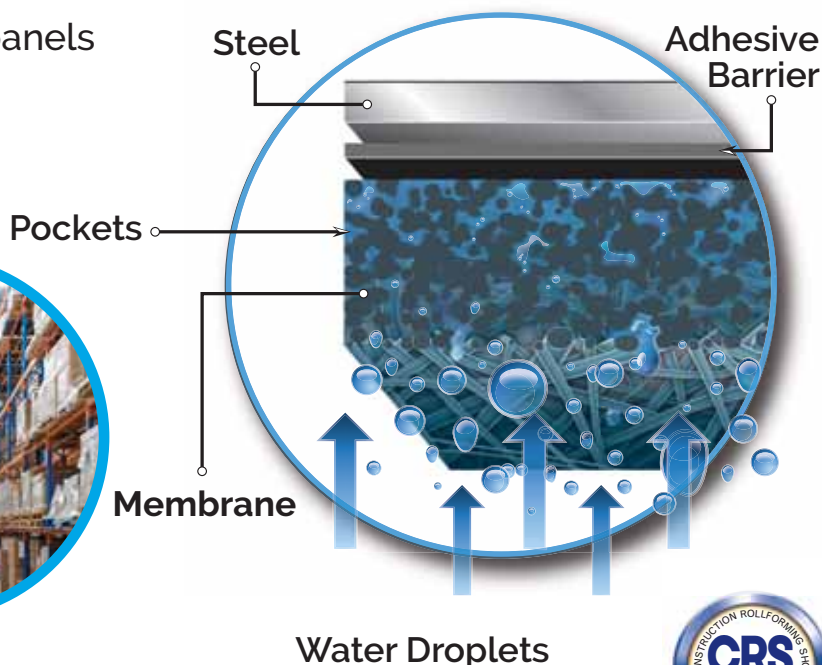

DRIPSTOP
Condensation control



Fight Condensation Without Insulation

Ask for it from your preferred steel panel supplier

www.dripstop.com or call us at: 1-(937) 660-6646

MFM Building Products
 Ramco Supply
 Raytec Manufacturing
 Roll Former Corp.
 Snap-Z, Glick Metals
 Southern Tool and Supply
 ST Fastening Systems

SEALANTS, CAULKS, TAPES

American Building Components
 ABC Supply Co.
 Agway Metals
 Atlas Bolt & Screw
 Dynamic Fastener
 East Coast Fasteners
 EPDM Coatings
 GutterSupply.com

Leland Industries
 Levi's Building Components
 Marco Industries
 Nationwide Protective Coating
 Mfrs.
 SFS
 ST Fastening Systems
 Topps Products, Inc.
 Triangle Fastener

SKYLIGHTS

A.B. Martin Roofing Supply
 MWI Components
 Palram Americas

SNOW GUARDS/ICE PREVENTION

A.B. Martin Roofing Supply
 AceClamp
 Dynamic Fastener
 EDCO Products
 Fabral
 Graber Post Buildings
 GutterSupply.com
 Levi's Building Components
 Marco Industries
 Petersen Aluminum
 S-5! Attachment Solutions
 ST Fastening Systems

TRANSLUCENT PANELS

Agway Metals
 Fabral
 MWI Components
 Palram Americas

VENTS & CUPOLAS

A.B. Martin Roofing Supply
 AG-CO
 Atlas Bolt & Screw
 Cor-A-Vent, Inc.
 East Coast Fasteners
 Fabral
 Isaiah Industries, Inc.
 MWI Components
 Snap-Z, Glick Metals
 Ventco

METAL ROOFING PANELS

BATTEN PANELS

ABC Supply Co.
 Agway Metals
 Fabral
 Graber Post Buildings
 McElroy Metal
 Morin Corp, Kingspan
 Petersen Aluminum

BERMUDA PANELS

ABC Supply Co.
 CertainTeed

FOAM-CORE PANELS

ABC Supply Co.

**RIBBED PANELS,
 THROUGH-FASTENED**

A.B. Martin Roofing Supply
 American Building Components
 CertainTeed
 Everlast Metals
 Everlast Roofing
 Fabral
 Graber Post Buildings
 McElroy Metal
 Metal Panels, Inc.
 Morin Corp, Kingspan

QUALITY. INTEGRITY. KNOWLEDGE.

Supplying the nation's commercial roofing industry with exceptional metal products for over two decades.

- ▶ **GUTTERS/GUTTER COIL**
- ▶ **DOWNSPOUTS**
- ▶ **ELBOWS/OFFSETS**
- ▶ **GUTTER ACCESSORIES**
- ▶ **BRAKE METAL**

Fabricated in-house to your specifications with quality domestic metal.



CONTACT US to learn how we can help you streamline your projects and maximize your profits.

231-861-0050 | advarchsm.com



Private Residence, Chicago Installing contractor: Custom Installations
 Architect: Kipnis Architecture + Planning Distributor: Sheet Metal Supply General contractor: Shardon Builders
 Photographer: A.J. Brown Profile: Snap-Clad metal roofing Color: Weathered Zinc



Superior Support

“Petersen has great customer service. They’re really helpful with support behind the roofing products they manufacture – and their color selection stands out.”

-Sock Woodruff, Custom Installations, Inc.



Case study at PAC-CLAD.COM/CHICAGO-RES

PAC-CLAD.COM | INFO@PAC-CLAD.COM

IL: 800 PAC CLAD MD: 800 344 1400 TX: 800 441 8661
 GA: 800 272 4482 MN: 877 571 2025 AZ: 833 750 1935

Visit us at the IRE – booth 4212



Ramco Supply
Swenson Shear
Varco Pruden

**SHINGLE, SHAKE,
SLATE FACSIMILES**

Agway Metals
CertainTeed
DECRA Metal Roofing
EDCO Products

Isaiah Industries, Inc.
McElroy Metal
Rare Manufacturing

**STANDING SEAM,
MECHANICALLY SEAMED**

ABC Supply Co.
Agway Metals
Everlast Metals
Everlast Roofing

Fabral
McElroy Metal
Metal Panels, Inc.
Morin Corp, Kingspan
Petersen Aluminum
Ramco Supply
Sheffield Metals International
Swenson Shear
Varco Pruden

STANDING SEAM, SNAP-LOCK

A.B. Martin Roofing Supply
Advanced Architectural
Everlast Metals
Everlast Roofing
Fabral
Grabber Post Buildings
Isaiah Industries, Inc.
McElroy Metal
Metal Panels, Inc.
Morin Corp, Kingspan
Petersen Aluminum
Sheffield Metals International
Swenson Shear
Varco Pruden

TILE FACSIMILES

Rare Manufacturing

RESOURCES

ASSOCIATIONS

Metal Construction Association
Metal Roofing Alliance
Reflective Insulation Manufacturers
Association-International

BUSINESS MANAGEMENT MEDIA

Frame Building News
Garage, Carport & Shed Builder
Metal Roofing Magazine
Idea Book, The
Rollforming Magazine
Rural Builder
Source Book, The

**FINANCIAL & INSURANCE
SERVICES**

Viking Equipment Finance

TRADE SHOWS

Construction Rollforming
Show 2020
International Roofing Expo
METALCON 2020
Remodeling Show

**RETROFIT ROOFING
PRODUCTS**

ABC Supply Co.
AppliCad USA
CertainTeed
Covertch - rFoil Insulation
Englert Inc.
Fabral
Metal Roofing Alliance
Petersen Aluminum
Ramco Supply
Triangle Fastener

ROOF RECOATINGS

Arkema, Inc.
Dura Coat Products
Dynamic Fastener
EPDM Coatings
Kynar Aquatec

Fix Roof Leaks GUARANTEED!

The **ONLY LIQUID**
EPDM Ruber in the World!

Liquid EPDM vs. Other Coatings

- 18-20 Year Expectancy with our one-coat system!
- Waterproofs immediately upon application
- Withstands ponding water 365 days a year
- Withstands temps from -40F to 300F
- One coat application-save product and labor costs
- Proven to outperform and outlast Acrylics & Elastomeric 4 Times longer
- Catalyst based to ensure a chemical air-tight seal on your roof
- **Warrantied** and **Guaranteed** not to leak in ponding water situations





BEFORE



AFTER



BEFORE



AFTER

855-281-0940

EPDM coatings

www.epdmcoatings.com



Authorized Distributor of Proguard

DYNA-GUARD®



IT IS TIME FOR A
CHANGING OF THE
GUARD

DYNA-GUARD® is a snow retention system designed to be installed on metal roofs. We are discontinuing the line of **S-5!** and related products. Please call for our close-out prices on S-5!®



DYNA-GUARD® Snow Retention System installed on a metal roof.



DYNA-CLIP

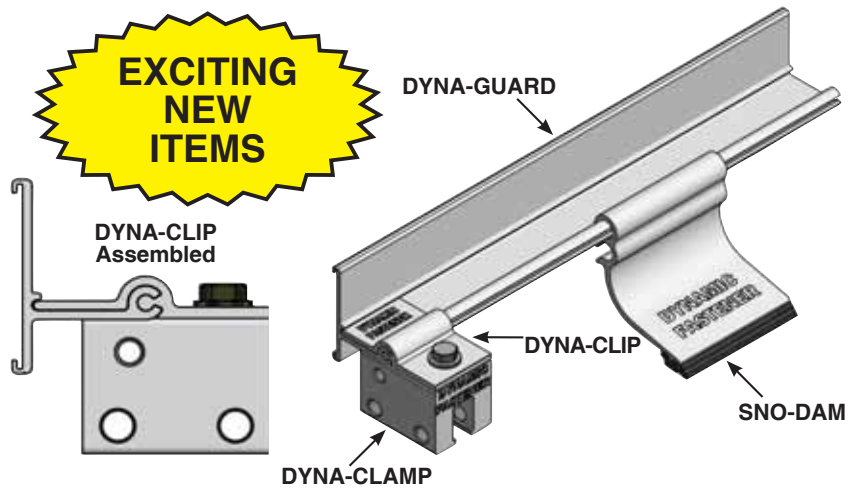

DYNA-CLIPS™

Clips for connecting

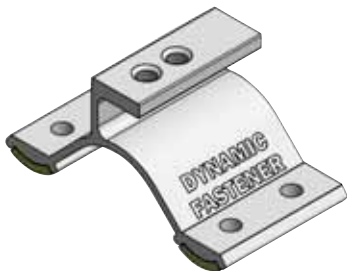

DYNA-CORR™

Attach almost anything to a corrugated roof

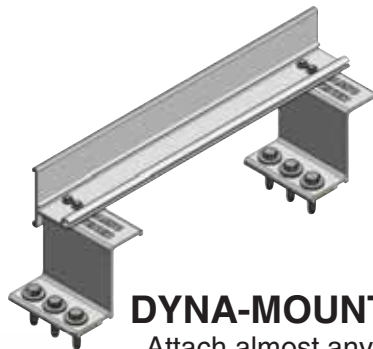

DYNA-MOUNTS™

Attach almost anything to an exposed fastener trapezoidal roof



Retro SNO-DAMS®

Retro-fit existing DYNA-GUARD by pressing these onto an installed system



DYNAMIC FASTENER • 800-821-5448

S-5! is a registered trademark of Metal Roof Innovations Ltd. DYNA-GUARD, DYNA-CLAMP and SNO-DAM are registered trademarks of Dynamic Fastener Service Inc. DYNA-CLIP, DYNA-CORR & DYNA-MOUNTS are trademarks of Dynamic Fastener Service Inc.

Nationwide Protective Coating Mfrs.
Topps Products, Inc.

SOFTWARE

Applicad USA
Paragon Computing
Rockwell Automation

TOOLS & EQUIPMENT

BRAKES, JOBSITE

ASC Machine Tools
Gary Machinery, LLC
John Stortz & Son
JS Design
Van Mark Products

BRAKES, SHOP

ASC Machine Tools
Gary Machinery, LLC
Hershey's Metal Meister

FASTENING TOOLS (SCREWGUNS, STAPLERS, NAILGUNS)

Atlas Bolt & Screw
BECK America
Dynamic Fastener
EDCO Products

GutterSupply.com
S-5! Attachment Solutions
Swenson Shear
Triangle Fastener

MACHINE CONTROLS DECOILERS

Acu-Form
ASC Machine Tools
Bradbury Co., Inc.
Gary Machinery, LLC
Hayes International
Hershey's Metal Meister
Marion Manufacturing
Roll Former Corp.
Zimmerman Metals

METAL CUTTING HAND TOOLS (SHEARS, NIBBLERS)

ABC Supply Co.
D.I. Roof Seamers
Dynamic Fastener
Gary Machinery
John Stortz & Son
JS Design
RUSTGO Mobile Work Platforms
Swenson Shear

METAL WORKING HAND TOOLS (CRIMPERS, FOLDERS, SEAMERS)

D.I. Roof Seamers
Dynamic Fastener
GutterSupply.com
John Stortz & Son
JS Design
Roll Former Corp.
RUSTGO Mobile Work Platforms
Southern Tool and Supply
Van Mark Products

MAGNETIC BROOMS

Dynamic Fastener
Van Mark Products

PANEL ROLL FORMERS, FIXED

Acu-Form
ASC Machine Tools
Bradbury Co., Inc.
Bradbury Group Australia
Bradbury Metal Tile Roofing Solutions
Hayes International
Hershey's Metal Meister
Marion Manufacturing
New Tech Machinery
Roll Former Corp.

Zimmerman Metals

PANEL ROLL FORMERS, PORTABLE

Acu-Form
Bradbury Co., Inc.
Bradbury Group Australia
Bradbury Metal Tile Roofing Solutions
Englert Inc.
GutterSupply.com
John Stortz & Son
New Tech Machinery
Roll Former Corp.
Zimmerman Metals

PANEL SHEARS

Acu-Form
ASC Machine Tools
Bradbury Co., Inc.
Dynamic Fastener
Hayes International
Hershey's Metal Meister
Marion Manufacturing
Swenson Shear

NEW

PLY-LO DRILLER

The latest innovation in drill point design

- **NEW** fast piercing drill point reduces dust and debris
- Featuring the original, patented Hi-Low threads
- Less prone to "walk" even when drilled at a slight angle
- **12 Year limited warranty**

Innovative drill tip design saves time on the jobsite

PATENT PENDING

East Coast
FASTENERS & CLOSURES, INC.

800-558-5895 ♦ www.plyco.com

BUILDING CONNECTIONS



UNITED
STEEL SUPPLY

Partnerships Matter to USS

Delivering a superior product while providing excellent customer service isn't something we take lightly at United Steel Supply. Our **slitting capabilities**, **just-in-time delivery** from our **nationwide distribution locations** and our **dedicated trucking partners** allow us to deliver on our commitment.

We look forward to supporting your business.

www.unitedsteelsupply.com

P: (512) 263-0954

E: sales@unitedsteelsupply.com



SEAMERS, POWERED

Bradbury Metal Tile Roofing Solutions
D.I. Roof Seamers
John Stortz & Son
Zimmerman Metals

SLITTERS, COIL

Acu-Form
ASC Machine Tools

Bradbury Co., Inc.
Gary Machinery, LLC
Hayes International
Marion Manufacturing
Van Mark Products

SOLDERING EQUIPMENT

Bradbury Metal Tile Roofing Solutions

TOOLS & EQUIPMENT, RAIN HANDLING

GUTTER FORMING MACHINES

ABC Supply Co.
Bradbury Group Australia
EDCO Products
Englert Inc.
GutterSupply.com
New Tech Machinery

GUTTERS, DOWNSPOUTS, EAVE TROUGHS, DRAINAGE

ABC Supply Co.
Advanced Architectural
Graber Post Buildings
GutterSupply.com
Petersen Aluminum

GUTTER HOODS/COVERS

GutterSupply.com
Midwest Enterprises
Raytec Manufacturing
Roll Former Corp.
Van Mark Products

GUTTER ACCESSORIES

ABC Supply Co.
Advanced Architectural
EDCO Products
Filc USA - DR!PSTOP
GutterSupply.com
Raytec Manufacturing

GUTTER INSERTS

GutterSupply.com

GUTTER HANGERS & FASTENERS

Advanced Architectural
Day Glow Inc.
EDCO Products
GutterSupply.com
Leland Industries
Raytec Manufacturing

TOOLS & EQUIPMENT, SAFETY/FALL PROTECTION

ABC Supply Co.
Dynamic Fastener
Metal Plus, LLC
RUSTGO Mobile Work Platforms
Southern Tool and Supply
Triangle Fastener

UNDERLAYMENT

ABC Supply Company, Inc.
Agway Metals, Inc.
Covertch - rFoil Insulation
Englert Inc.
Fabral
Filc USA - makers of DR!PSTOP
Isaiah Industries, Inc.
Levi's Building Components
Marco Industries
MFM Building Products
NOFP, Inc.
Reflective Insulation Manufacturers Association-International
RoofTopGuard SA
Sharkskin Roof Underlayment
Titanium Synthetic Roof Underlayment

HIGH TEMP SELF ADHERING

ULTRA HT

WIND & WATER SEAL™

**MAX TEMP 250°F
NON-SLIP SURFACE**

Ultra HT Wind & Water Seal™ is the premium high temperature underlayment designed to keep you cool in the most extreme conditions. Discover all the advantages that Ultra HT offers on your next project.

- > Tough, durable cross-laminated top film surface
- > Maximum protection against extreme heat, rain or ice dams
- > Non-slip polymer surface for excellent foot traction
- > Self-adhering and self-sealing for a complete waterproof bond
- > ICC-ES ESR-1737, Florida Building Code FL#11842, Miami-Dade County Approved and CCMC 14048-L

Visit mfmbp.com for FREE Samples and Downloads today.

mfm BUILDING PRODUCTS CORP. (800) 882-7663

MIAMI-DADE COUNTY APPROVED

Why **SHARKSKIN**? We Outperform the Competition!



*Photo courtesy of Tremco,
Contractor Eberhart Roofing
and Waterproofing, Jobsite
Newbury Park, CA*



877.742.7507



www.sharkskinroof.com



COMPANY DIRECTORY



A. B. Martin Roofing Supply, LLC

82 Garden Spot Rd.
Ephrata, PA 17522
888-606-1094
717-977-5175 (fax)
sales@abmartin.net
www.abmartin.net

For 70 years, A.B. Martin has been manufacturing metal roofing and supplying building materials to hard-working builders just like you. To make your life easier, we stock over 35,000 building products that are ready at short notice to be loaded and delivered to your jobsite.



ABC (American Building Components)

1099 US-421
Frankfort, KY 40601
859-877-4406
800-877-8709
800-784-6058 (fax)
contact@abcmetal.com
www.abcmetalroofing.com

AMERICAN SINCE 1908 — Tirelessly committed to quality products and exceptional service, American Building Components (ABC) has built a strong reputation of providing premium metal roofing and building solutions that customers have relied on for more than a century. Servicing primarily the agricultural, residential, commercial and post-frame markets, ABC offers an expansive line of premium metal roofing and siding panels in both 29- and 26-gauge steel, as well as accompanying trim and accessories. In addition, we offer roll-up doors, steel buildings and insulated metal panels all under one roof for your convenience. Utilizing our nationwide network of manufacturing facilities and distributors, as well as our top grade painting technologies in our coating facilities, our painted steel is backed by industry-leading warranties that assure your projects will stand the tests of time. ABC metal roof and wall panels, trim and accessories are available to order online.



ABC Supply Company, Inc.

One ABC Parkway
Beloit, WI 53511
608-362-7777
608-362-2062 (fax)
jeff.garrow@abcsupply.com
www.abcsupply.com

ABC Supply is the largest wholesale distributor of roofing in the United States and one of the nation's largest distributors of siding, windows and other select exterior building products.



AceClamp

87 Spring Ln.
Plainville, CT 06062
860-351-0686
860-351-0689 (fax)
sales@pmcind.com
www.aceclamp.com

AceClamp® manufactures fast-installing, precision-engineered snow retention and solar mounting solutions that are compatible with almost any roof type. Our pre-assembled, patented, non-penetrating "slide-pin" metal roofing clamp eliminates the need for set screws, helping to protect the metal roofing panel's finish from installation damage. Simplify inventory with one clamping system.



Acu-Form

10550 Township Rd. 262
Millersburg, OH 44654
330-674-4003
330-674-4035 (fax)
acu-form@safecommmail.com

Acu-Form (a division of Paint Valley Parts) is a manufacturer of metal-forming equipment, such as the Ag Panel, Post Cut Shear, Uncoiled, Corner, J-Channel, Ridge Cap, Rat Guard, Hemmer, Slitter, Wrapper, etc. Also, machines made to your specs. Our goal is to meet and exceed our customer's expectations. Our No. 1 priority is to send our customer a durable top-performing machine that will give them years of trouble-free service.

Advanced Architectural Sheet Metal & Supply, Inc

131 W. 2nd St.
Shelby, MI 49455
231-861-0050
231-861-0075 (fax)
info@advarchsm.com
www.advarchsm.com



AG-CO

701 W. State St.
St. Johns, MI 48879
800-522-2426
paul@ag-co.com
www.ag-co.com

Cupolas by AG-CO are easy to install (only 3 pieces, including weathervane), low maintenance, and economical. The cupolas come in 13 different top colors, 13 bottom section colors, and 15 different weathervanes. With thousands of combinations, your customers are sure to get a unique and attractive addition to their building!

Agway Metals, Inc.

170 Delta Park Blvd.
Brampton, ON L6T 5T6
226-747-7293
866-254-0115 (fax)
gzimmer@agwaymetals.com
www.agwaymetals.com

AkzoNobel

AkzoNobel

1313 Windsor Ave.
Columbus, OH 43211
800-294-3361
coil.coatings@akzonobel.com
www.akzonobel.com/cna

AkzoNobel manufactures high-performance coatings to meet the needs of the metal construction industry. Our products include TRINAR, a 70 percent PVDF coating, and CERAM-A-STAR 1050, the benchmark of SMP paint systems. Both products are available in our Cool Chemistry formulations, which help make projects more energy efficient and sustainable. AkzoNobel coatings are widely specified for their excellent performance and durability, as well as their color and gloss retention.



AppliCad USA, Inc.

1340 US Highway One
Jupiter, FL 33469
541-748-0545
561-748-0546 (fax)
ray@applicad.com
www.applicad.com



Arkema, Inc.

900 First Ave.
King of Prussia, PA 19406
610-205-7874
ron.partridge@arkema.com
www.kynar500.com

Arkema proudly offers Kynar 500® FSF® technology for use in superior performance metal roof coatings. Celebrating over fifty years of proven protection, Kynar® resin-based coatings provide protection against weathering, aging, and pollution on commercial, industrial and residential buildings worldwide. Arkema produces Kynar 500® FSF® PVDF resin using a patented fluorosurfactant-free (FSF®) process. No fluorosurfactant of any kind is used to manufacture Kynar 500® resin making it a key component of sustainable design.

Arkema, Inc.

900 First Ave.
King of Prussia, PA 19406
610-205-7000
800-225-7788
610-205-7913 (fax)
arkema.usph-general@arkema.com
www.arkema-americas.com

COMPANY DIRECTORY



ASC Machine Tools, Inc.

900 N. Fancher Rd.
Spokane, WA 99212
509-534-6600
509-536-7658 (fax)
salesupport@ascmt.com
www.ascmt.com

With more than 70 years of experience we have developed a reputation for innovation, quality and responsiveness in the design of our rollforming machinery. ASC manufactures the industry's most innovative rollforming equipment to produce Roof and Wall Panels, Trim Profiles, C/Z Purlins, Grain Bin Components, Decking and much more! Let us "Shape Your Success"!



Atlas Bolt & Screw Co., LLC

1628 Troy Rd.
Ashland, OH 44805
800-321-6977
419-289-2564 (fax)
mrogowski@atlasfasteners.com
www.atlasfasteners.com

Atlas Bolt & Screw, the industry leader, has the widest selection of metal wood fasteners, closures, venting, sealing, flashing, and exterior building performance solutions. Headquartered in Ashland, Ohio, with manufacturing and distribution located in Ohio, Texas, Oregon, and North Carolina. "We make the complex simple and the difficult easy."

Aztec Washer Co., Inc.

13821 Danielson St.
Poway, CA 92064
858-513-4350
858-513-4305 (fax)
mattd@aztecwasher.com
www.aztecwasher.com



BECK America

105 Industrial Park Drive
P.O. Box 2389
Muscle Shoals, AL 35661
800-239-8665
sales@fascoamerica.com
www.beckamerica.com

BECK America is the Master Distributor for products manufactured by The BECK Group®, a leader for generations in pneumatic tool and fastener development and creator of the RoofLoc® SCRAIL® Metal Roofing System.

Becker Specialty Corp.

2526 Delta Ln.
Elk Grove Village, IL 60007
847-766-3555
847-766-3595 (fax)
info-beckerspecialty@beckers-group.com
www.beckers-group.com



Hangtite™

Gutter Hanger
with Clip



Hangfast®

Gutter Hanger



REAL®

Gutter Cover



FLASHING

Step ■ Apron ■ Roll



Rezist™



See more at RaytecLLC.com

CALL (877) 800-2500

Email Sales@RaytecLLC.com



THE BRADBURY CO., INC.

Bradbury Co., Inc., The

1200 E. Cole
Moundridge, KS 67107
620-345-6394
620-345-6381 (fax)
bradbury@bradburygroup.com
www.bradburygroup.com



Bradbury Group Australia

82-88 Meakin Rd.
Meadowbrook, QLD 4131
+61 7 3299 3111
+61 7 3299 5511 (fax)
bradbury@bradburygroup.com
www.bradburygroupaustralia.com



Bradbury Metal Tile Roofing Solutions

190 Riri St.
Rotorua,
+64.7.343.6190
bradbury@bradburygroup.com
www.bradburymetaltiles.com



Building Products Development, Inc.

1100 E. Main St.
Logansport, IN 46947
866-766-3254
574-722-5543 (fax)
sales@wegotclips.com
www.wegotclips.com

Building Products Development (BPD) is a leading metal roof clip manufacturer in the United States. BPD offers a full line of high-quality clips and accessories for all standing seam profiles. With large stock readily available, BPD is able to process and ship most orders on the same day.



CertainTeed

20 Moores Rd.
Malvern, PA 19355
800-233-8990

www.certainteed.com/metal-roofing

CertainTeed Roofing is a leading manufacturer of roofing products and systems. CertainTeed's Matterhorn Metal Roofing line features three distinct aesthetic profiles (Shake, Slate and Tile) that expertly replicate the design of classic roofing in the form of tough, lightweight steel panels that are ideal for residential and light commercial application.



Construction Rollforming Show 2020

PO Box 255
Iola, WI 54945
715-252-6360
gary@shieldwallmedia.com
www.constructionmagnet.com
Join us for the second annual show to be held December 10-11, 2020, Duke Energy Center, Cincinnati, Ohio. Presented by Rollforming Magazine, this show is the only show exclusively devoted to the construction roll-forming industry. The show offers the latest in machines, and best business practices for the professional.

Cor-A-Vent, Inc.

PO Box 428
Mishawaka, IN 46546-0428
800-837-8368
800-645-6162 (fax)
info@cor-a-vent.com



Covertch - rFoil Insulation

279 Humberline Dr.
Etobicoke, ON M9W 5T6
416-798-1340
416-798-1342 (fax)
johnstarr@covertchfab.com
www.rfoil.com

rFoil is a single or double layer of polyethylene bubbles bonded to and sandwiched between a highly reflective surface and a white polyethylene sheet. It is ideal for many residential and commercial application including walls, ceilings and roofs. Adding rfoil to your construction project improves the insulation value and significantly increases its energy efficiency.

D.I. Roof Seamers

915 Hwy. 45
Corinth, MS 38834
888-343-0456
662-287-6744 (fax)
sales@dimetalworks.com
www.diroofseamers.com



Day Glow Inc.

No. 921-11, Chungshan Rd., Sec. 2, Tachia Dist.
Taichung City, Taiwan 43767
886-4-268-14343
886-4-268-14304 (fax)
dayglow@dayglow.com.tw
www.dayglow.com.tw
Day Glow Inc. is a specialist maker of Drilling and Tapping screws, since 1996. Located in Tai'Chung, Taiwan. Day Glow

has several years' experience in metal building construction. Hence realize the important of screws. We focus on producing high quality screws. Besides standard screws Day Glow also provides customized screw producing.

DECRA Metal Roofing

1230 Railroad St.
Corona, CA 92882
877-GO-DECRA
951-272-4476 (fax)
marketing@decra.com
www.decra.com



Dura Coat Products, Inc.

5361 Via Ricardo
Riverside, CA 92509
951-341-6500
951-341-6505 (fax)
info@duracoatproducts.com
www.duracoatproducts.com
Dura Coat Products offers two high-performance coil coatings. Durapon 70™ is a PVDF formulation with exceptional durability and fade resistance that is also available with thick film primer for the tougher environments. Ceranamel™ XT-40 SMP is a proprietary polymer that is harder yet more flexible than ordinary coatings. Both are Energy Star compliant. Hydropon is a new air-dry, field-applied, water-base PVDF for recoating old metal roofs and siding.



Dynamic Fastener

9911 E. 53rd Street
Raytown, MO 64133
800-821-5448
800-844-1199 (fax)
kenwebb@dynamicfastener.com
www.dynamicfastener.com

Offers same-day shipping of screws, anchors, flashings, safety equipment, hand tools and power tools. In-house painting of screws and rivets, with one- or two-day lead-time. Dyna-Guard snow retention system for metal roofs. Dyna-Clamps are available to accommodate many profiles of standing seam roofs. The company's free 140-page, full color, tool and fastener hand guide provides engineering data and also details product offering.



East Coast Fasteners

PO Box Q
Elkhart Lake, WI 53020
800-558-5895
800-257-5926 (fax)
kpope@plyco.com
www.plyco.com

East Coast supplies a variety of Long Life, Fast Drilling construction fasteners that meet your building needs, and backed by quick shipping programs to serve our customers. We stand behind our products, we don't just talk about them.



EDCO Products, Inc.

8700 Excelsior Blvd.
Hopkins, MN 55343
952-945-2680
952-938-9244 (fax)
sales@edcoproducts.com
www.edcoproducts.com



Englert Inc.

1200 Amboy Ave.
Perth Amboy, NJ 08861
800-364-5378
732-826-8865 (fax)
info@englertinc.com
www.englertinc.com

For over 50 years Englert has been providing high quality metal roofing, wall panels and gutter systems painted on our own state-of-the-art coil coating line. We've also brought manufacturing to the jobsite with our wide selection of portable roll-forming machines.



EPDM Coatings

494 Bridgeport Ave., Suite 101-342
Shelton, CT 06484
610-298-1989
702-977-2936 (fax)
info@epdmcoatings.com
www.epdmcoatings.com

Fix roof leaks once with Liquid Rubber, the only liquid EPDM in the world. It provides a new roof at a fraction of the cost. With a 25-year history of success, this one-coat application has been proven in laboratory testing to last three times longer than elastomers. Save time and money with a do-it-yourself application. Takes submerged water 365 days a year. Don't forget to ask about volume discounts! EPDM coating was awarded Top 10 Product honors by Metal Roofing Magazine.



Everlast Metals

10 Enterprise Ct.
Lebanon, PA 17042
866-418-5057
717-270-6569 (fax)
www.everlastmetals.com

Everlast Metals offers architectural metal roofing and wall



panel systems, available in 24 gauge steel and aluminum. Everlast Metals offers an extensive color selection of slit coil and flat sheet. Strategically located throughout the New England, Mid-Atlantic and Midwestern states, Everlast Metals can serve your every need.



Everlast Roofing, Inc.

10 Enterprise Ct.
Lebanon, PA 17042
717-270-6554
888-339-0059
717-270-6569 (fax)
info@everlastroofing.com
www.everlastroofing.com

Everlast manufactures a variety of quality, high-performance metal roofing and siding materials for architectural, commercial, industrial, post-frame and residential markets, offering a wide range of gauges, colors and custom trims.

LELAND Specialty Fasteners

Master Grippers® • Grippers MDP®

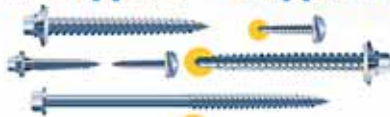

For the post frame building industry • MDP metal panel to wood or light steel girt or purlin.

Master Drillers®



Attach metal panel to metal girt or purlin, stitching & structural applications. Lengths to 8" available.

Master Tappers®



Roof panel to panel - roof sheet to structural
A - AB - B points available, type F, type 23, type 1, BP & more. Lengths to 8" available.

Master Deckers®



ACQ compatible decking screws. Lengths to 6" available.



Our Powder Coated paint system allows us to match your painted steel supplier's warranty.



1.800.263.3393
www.lelandindustries.com

071719_12



FABRAL[®]

METAL WALL AND ROOF SYSTEMS

Fabral

30 Technology Parkway S.
Suite 400
Norcross, GA 30092
800-477-2741
info@fabral.com
www.fabral.com



Fabral is the premier supplier of metal roofing and siding and manufactures one of the most extensive product lines available for post frame, agricultural, residential, architectural, commercial, and industrial applications. Fabral's total system offering includes a wide selection of standing seam roof profiles and both exposed fastener and concealed fastener panels - available in a variety of substrates, gauges and color and accessories, including CondenStop, underlayment, snow retention, and copper accents.



Filc USA - makers of DR!PSTOP

10118 Settlement House Rd.
Dayton, OH 45458
937-660-6646
937-999-3927 (fax)
info@dripstop.com
www.dripstop.com

DRIPSTOP is the world's best-selling condensation control membrane thanks to being the solution most builders turn to and trust. Builders eliminate the hassle of installing insulation or vapor barriers since DRIPSTOP absorbs moisture as it appears in the building overnight, and releases it as normal humidity during the day. Filc USA is also proud to present Steel Shield, a new residential product that protects the underside of the steel against abrasion during reroofing.

FRAME BUILDING NEWS

Frame Building News

PO Box 255
PO Box 255
Iola, WI 54945
715-252-6360 (Gary)
www.constructionmagnet.com

Frame Building News has been devoted exclusively to coverage of the post-frame construction industry for the past 30 years. It has more than 19,000 subscribers, most of which make their living in the post-frame industry. It is published five times a year. For editorial questions contact Karen@shieldwallmedia.com. For advertising opportunities contact Gary@shieldwallmedia.com.



Garage, Carport & Shed Builder

PO Box 255
Iola, WI 54945
715-252-6360 (Gary)
www.constructionmagnet.com

Scheduled to debut in early 2020 is the only industry publication focused exclusively on the unique segment of residential construction involving sheds, garages, and car

ports. Our goal is to help our readers win in a competitive market through improved creativity, marketing, and best practices to offer a top-quality product while remaining price competitive. Publisher is Shield Wall Media, also the publisher of Metal Roofing Magazine, Rural Builder, Rollforming Magazine, Frame Building News, and the Construction Rollforming Show.

Gary Machinery, LLC

1931 E. Main St.
Griffith, IN 46319
219-980-5700
219-980-0405 (fax)
sales@garymachinery.com
www.garymachinery.net



Graber Post Buildings

7716 N. 900 E.
Montgomery, IN 47558
800-264-5013
812-636-4936 (fax)
info@graberpost.com
www.graberpost.com

A leading company in the post-frame industry for roll-formed metal, custom trusses, and metal roofing. Graber manufactures and distributes numerous components for post-frame structures. It is a complete, post-frame building package company, a "One Stop Shop."



GutterSupply.com

19 Skokie Valley Rd.
Lake Bluff, IL 60044
888-909-7246
847-283-0007 (fax)
info@guttersupply.com
www.GutterSupply.com

GutterSupply.com has been a resource to contractors nationwide for years. We have over 3,000 gutter related products at your fingertips. Detailed information, videos, CAD drawings, spec sheets, manuals and more. We provide you with the information and tools you need to run a successful gutter business. Be sure to check out our new Quick Shop function featuring materials lists by specific job types.



Hayes International

1200 E. Cole
Moundridge, KS 67107
620-345-6394
620-345-6381 (fax)
bradbury@bradburygroup.com
www.bradburygroup.com



Hershey's Metal Meister

420 Progress Dr.
Mattoon, IL 61938
877-289-3030
217-234-4702 (fax)
info@hersheysmm.com

Discover the advantages of the Variobend USA folding machine! A unique hybrid of European design and American manufacturing; get the best of both worlds! Need parts? No need to look beyond the massive parts inventory at Hershey's! Call today to see how we can help you succeed!

Hexion, Inc. - Epoxy, Phenolic & Coating Resins Division

180 E. Broad St.
Columbus, OH 43215
614-225-4000
888-443-9466
614-986-2496 (fax)
4information@hexion.com
www.hexion.com



International Roofing Expo

6191 N. Highway 161, Suite 500
Irving, TX 75038
972-536-6415
972-536-6410 (fax)
morgan.harper@informa.com
www.TheRoofingExpo.com

Join over 14,000 roofing professionals for the industry's largest event - the International Roofing Expo. At the IRE you will make connections with both residential and commercial contractors, remodelers, distributors, estimators, specifiers, architects, engineers, builders, and manufacturers. Explore thousands of products from over 500 brands, select from over 40 education sessions, participate in the 11th annual Community Service Day, take part in NRCA events, attend networking receptions, and more. Join us in Dallas, Texas, February 4-6, 2020!



Isaiah Industries, Inc.

8510 Industry Park Dr.
PO Box 701
Piqua, OH 45356
800-543-8938
937-778-5116 (fax)
info@isaiahindustries.com



www.isaiahindustries.com

Isaiah Industries is a collection of brands that represent integrity, sustainability, energy-efficiency and durability. We're in the business of providing the very best permanent roofing solutions across North America and the globe. Our commitment to quality products AND quality relationships, make a difference and help protect people's homes, places of worship and places of business.



John Stortz & Son, Inc.

210 Vine Street
Philadelphia, PA 19106
215-627-3855
215-627-6306 (fax)
jeff@stortz.com
www.stortz.com

Since 1853, John Stortz & Son has manufactured and distributed the highest quality metal roofing tools and associated products. Specializing in standing seam, we offer a full line of metal roll benders, soldering equipment, seamers, pliers, hammers, gutter tools, snow guards and more.

JS Design

13125 Deer Lake Dr.
Memphis, IN 47143
812-248-4788
www.metalttools.com



Kynar Aquatec

900 First Ave.
King of Prussia, PA 19406
610-205-7874
ron.partridge@arkema.com
www.kynaraquatec.com

Kynar Aquatec® PVDF latex is formulated into water-based, metal restoration coatings that provide the durability and performance of traditional Kynar 500® resin based coatings. Now the extreme weatherability of a Kynar 500® resin based coating is available in a VOC compliant, field or factory applied ambient air dry system with tremendous resistance to dirt pick-up, outstanding water repellency and high initial and long-term Total Solar Reflectance and Emissivity.



Leland Industries, Inc.

95 Commander Blvd.
Toronto, ON M1S 3S9
1-800-263-3393
416-291-0305 (fax)
info@lelandindustries.com
www.leland.ca



A domestic manufacturer for the metal roofing and cladding industry. Leland produces a complete line of screws for metal to metal and metal to wood frame structures. Lengths to 8 inches are available and all fasteners are plated with Leland's exclusive JS1000. Powder coating is available in colors to match any panel color.

Levi's Building Components

137 Newport Rd.
Leola, PA 17540
877-897-7020
717-656-2558 (fax)

sales@levisbuildingcomponents.com
www.levisbuildingcomponents.com

Liberty Steel Products

11650 Mahouing Ave.
North Jackson, OH 44451
330-538-1203
330-538-2952 (fax)
bcheeks@liberty-steel.com
www.libertysteelproducts.com



**Fade Resistant
Protected Over/Under Head**



Powerful™

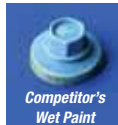

Competitor's
Wet Paint



**No Red Rust
Molded Not A Cap**



Corrosive Resistant
ZAMAC Head



Red Rust
Competitor's
Carbon Head



**Reduce Strip Out
Grips Soft Fibers**



Powder coating outperforms wet paint in resistance to corrosion, chemicals, heat, impact, abrasion, UV rays and extreme weather conditions. Wet paint fades, Powderful coating matches metal panels for decades. The wet paint process emits 1000's of lbs. of harmful VOCs daily, but the Powderful coating process releases none.



2019
Color Chart

The industry's most corrosive resistant die-cast molded integral cupped head combines a fade resistant Powderful coating with the guaranteed not to RED RUST properties of ZAMAC. Cupped head maintains a positive seal at any angle. No RED RUST is a value both you and your customer can see. Better looking buildings make for better sales.

**CALL TODAY
1-800-352-4864**



The STRIP LOC thread design resists the expansion & contraction that is found in metal roofing applications keeping the metal panels securely fastened to the OSB. The strength of the STRIP LOC thread design greatly reduces the potential for fastener strip out in OSB, enabling the full pullout value to be realized, thus protecting your valuable metal panel investment.



Marco Industries

4150 S. 100th E. Ave., Suite 301
Tulsa, OK 74146
800-800-8590
918-622-4536 (fax)
info@marcoindustries.com
www.marcoindustries.com

We make the best roofing ventilation and accessories for metal roofs - period! With the most tested and certified products on the market, you can trust our solutions to perform in even the harshest conditions, protecting your roof and everything underneath. Only Marco offers the Weather-Tite System, a comprehensive line of metal roofing solutions that offer easy installation, remarkable building ventilation, lower utility costs, extreme durability, and outstanding warranties. For more information check out MarcoIndustries.com or call 800-900-8590. If it's not proven, It's not Marco.

Marion Manufacturing

201 S. Coble
Marion, KS 66861
620-382-3751
620-382-2322 (fax)
sales@marionmanufacturing.com
www.marionmanufacturing.com



Maze Nails

PO Box 449
Peru, IL 61354
800-435-5949
815-223-7585 (fax)
info@mazenails.com
www.mazenails.com



McElroy Metal

1500 Hamilton Rd.
Bossier City, LA 71111
800-562-3576



318-747-8059 (fax)
info@mcelroymetal.com
www.mcelroymetal.com
McElroy Metal markets one of the industry's most extensive lines of metal roofing systems. From residential to commercial, McElroy's product selection includes a broad variety of systems that would be ideal for any project. McElroy also offers trim and accessories to match, so we are your one stop shop for all of your roofing needs. McElroy operates 13 manufacturing facilities across the United States.

Metal Construction Association

8735 W. Higgins Rd., Suite 300
Chicago, IL 60631
847-375-6416
nsteenber@connect2amc.com
www.metalconstruction.org
The Metal Construction Association is an organization of manufacturers and suppliers whose metal products are used in structures throughout the world. Since it was formed in 1983, MCA has focused on one key strategy - to promote the use of metal in the building envelope through marketing, education, and action on public policies that affect metal's use. The organization's major annual event is the METALCON Exhibition and Conference



ULTRA WHITE MBI
METAL BUILDING INSULATION
(2600 Series)



- Blocks 96% of Radiant Heat Transfer
- Prevents Interior Condensation
- Class 1 / Class A Fire-Rated (ASTM E84-09 / ASTM E2599-08)
- Puncture and Tear-Resistant
- Unaffected by Humidity
- Will not Promote Mold and Mildew
- Safe, Non-Toxic and Non-Carcinogenic
- Easy to Handle and Install
- UV-Resistant

The rFOIL-2600 is the first reflective bubble insulation to come with an unmatched 10 Year Guarantee against ultraviolet light degradation, delamination, cracking, peeling or flaking.

The guarantee includes new material and up to \$0.75 / sqft for any labor replacement costs.



Call Toll Free: 1-800-837-8961 or 416-798-1340
Email: sales@rfoil.com Website: www.rfoil.com





Metal Panels, Inc.

131 S. 147th E. Ave.
Tulsa, OK 74116
918-641-0641
918-641-0640 (fax)
contact@metalphanelinc.com
www.metalphanelinc.com
Metal Panels Inc. has been providing quality manufactured metal roofing and siding products, for the metal roofing, metal building and post-frame industries since 2001. MPI maintains manufacturing centers in Tulsa and Kansas City. MPI offers 19 panel profiles, curved panels, and all accessories for metal roofing and buildings.



Metal Plus, LLC

214 Wallens Hill Rd.
Winsted, CT 06098
860-379-1327
860-379-6016 (fax)
sales@metalplusllc.com
www.metalplusllc.com

Metal Plus, LLC is proud to announce that we not only distribute our line of standing seam metal roofing brackets, but we also are a major distributor for S-5!, DekTite and Berger, just to name a few!



Metal Roofing Alliance

PO Box 2799
Longview, WA 98632
360-431-1177
reneeramey@metalroofing.com
www.metalroofing.com

The Metal Roofing Alliance (MRA) is a non-profit organization focused on educating consumers about residential metal roofing and providing access to quality metal roofing products and installers.



Metal Roofing Magazine

PO Box 255
Iola, WI 54945
715-252-6360 (Gary)
www.constructionmagnet.com
Metal Roofing Magazine started as a supplement to Rural Builder, but quickly blossomed into its own publication with the growth of metal roofing. Within the pages of Metal

Roofing Magazine, readers discover projects and products relevant to their industry and business. Metal Roofing is published seven times a year and is geared toward the professional metal roofer, with tips, features, news and product profiles. For advertising opportunities contact Gary@shieldwallmedia.com. For editorial questions contact Sharon@shieldwallmedia.com



METALCON 2020

10 Midland Ave.
Newton, MA 02458
617-965-0055
617-965-5152 (fax)
lismany@metalcon.com
www.metalcon.com
October 21-23, 2020, Las Vegas, Nevada.



MFM Building Products

525 Orange St.
Coshocton, OH 43812
740-622-2645
740-622-6161 (fax)
info@mfmmbp.com
www.mfmmbp.com

MFM manufactures a line of high temperature rated underlayments specifically designed for use under metal roofing systems where high heat is generated. These 36" wide underlayments come with an aggressive asphalt adhesive system, split release liners for ease of installation and offer excellent foot traction. FREE samples available through the website.



Midwest Enterprises

PO Box 189
Saint Clair, MO 63077
800-748-7736
636-629-3177 (fax)
sales@e-zgutter.com
www.e-zgutter.com

Midwest Enterprises offers the hardest working guards in the business, with an innovative design for every type of gutter and debris load. Midwest Enterprises manufactures a wide variety of painted, brushed aluminum, powder coated and copper gutter guard protection products and sells them nationally through a wide network of distributors. E-Z Gutter Guard Protection products are engineered for higher performance under heavy rain and wind, with special channels and bends engineered-in to add strength, help water drop through faster, and help keep the guards tightly in place.

Momentive Performance Materials, Inc.

260 Hudson River Rd.
Waterford, NY 12188
614-986-2495
800-295-2392
614-986-2496 (fax)
commercial.services@momentive.com
www.momentive.com



A Kingspan Group Company

Morin, A Kingspan Group Company

685 Middle St.
Bristol, CT 06010
800-640-9501
860-582-7503 (fax)
sales@morincorp.com
www.morincorp.com

Morin Corporation specializes in roll forming of Architectural Single Element Heavier Gauge Metal Cladding Walls and Roofs. With over six dozen profiles (over 3 wall panels interlock) and three manufacturing locations, Morin is well positioned to produce for any size project. #morincorp



MWI Components

1015 32nd Avenue W.
Spencer, IA 51301
800-360-6467
800-361-3452 (fax)
info@mwicomponents.com
www.mwicomponents.com

MWI Components is a leading manufacturer/supplier of products for the post-frame industry. We provide cost-competitive, quality products with the shortest lead-time and best customer service in the industry. Create beautiful buildings using our wide range of colors and assorted components. Call MWI to make your buildings stand out!



Nationwide Protective Coating Mfrs., Inc.

7106 24th Court E.
Sarasota, FL 34243
800-423-7264
941-753-1773 (fax)
info@natcoat.net
www.nationwidecoatings.com



New Tech Machinery

1300 40th St.
Denver, CO 80205
800-574-1717
303-294-9407 (fax)
sales@newtechmachinery.com
www.newtechmachinery.com

New Tech Machinery manufactures the world's finest portable roof panel and gutter machines. Located in Colorado, we have distributors worldwide and our equipment has been shipped to over 30 different countries. We offer innovation, high quality equipment and unmatched customer service.



**High Performance Insulation
NOFP, Inc.**

725 Enterprise Dr.
Wauseon, OH 43567
419-335-4850
800-339-4850
419-335-2380 (fax)
info@nofp.com
www.nofp.com, www.thebarrier.com

Northwestern Ohio Foam Products manufactures high performance reflective foil insulation and roll-out under-concrete radiant floor insulation for commercial, agricultural and residential construction. NOFP's broad product line provides energy efficient and green building solutions for every insulation requirement, from insulating your new metal building or post-frame building to insulating underneath your concrete for radiant heated slabs.



Palram Americas

9735 Commerce Cr.
Kutztown, PA 19530
800-999-9459
610-285-9928 (fax)
palramamericas@palram.com
www.palramamericas.com

Palram continues to expand its SunSky® polycarbonate panel line for the largest selection of day lighting and side lighting options. Palram's proprietary MetalMatch® technology can match virtually any corrugated metal panel profile available. Palram also offers a complete line of Ag-Tuf® PVC liner panel for interior and exterior use.



Paragon Computing Solutions, LLC

1069 Red Run Rd.
Stevens, PA 17578
866-971-0940
sales@goparagon.com
https://goparagon.com

Paragon Computing Solutions helps building supply companies break from disjointed systems by delivering streamlined software that increases your output.



Petersen Aluminum Corp.

1005 Tonne Rd.
Elk Grove Village, IL 60007
800-PAC-CLAD
800-722-7150 (fax)
sales@petersenmail.com
PAC-CLAD.com



Petersen, a Carlisle company, manufactures PAC-CLAD metal cladding products in multiple gauges of steel and aluminum, including standing seam roof panels, hidden- and exposed-fastener wall panels, soffit panels, perforated metal, coil and flat sheet, fascia, coping and composite panels. All are available in 70% PVDF finish in 45 standard colors.



Prassas Metal Products

1411 W. 190th St. #360
Gardena, CA 90248
310-217-4533
800-294-3427
310-217-4530 (fax)
pmpsteel@yahoo.com
www.pmpsteel.com

PMP Steel is a 29-year-old steel trading company and coated coil distributor, specializing in pre-painted Galvalume, acrylic Galvalume, and galvanized coil products. PMP competitively supplies both import and domestic mill product to all major USA markets and a wide variety of industry applications, such as residential roofing, metal buildings, and garage doors. PMP maintains coil distribution centers at Savannah, GA and Tampa, FL, stocking 16 industry-standard colors of 40-year x "Cool" PPGL colors (29 ga, 26 ga), 20-colors of 29 ga Regular Polyester, and a full range of AZ55 acrylic-coated Galvalume coil for the metal building industry.

Ramco Supply

4572N Old US Hwy 31
Rochester, IN 46975
574-223-7802
574-223-7846 (fax)
sales@ramcosupply.com
www.ramcosupply.com

Rare Manufacturing, Inc.

19154-95A Ave.
Surrey, BC V4N 4P2
866-316-7273
604-882-2887 (fax)
info@raremanufacturing.com
www.raremanufacturing.com



Raytec Manufacturing

544 Gristmill Rd.
Ephrata, PA 17522
877-800-2500
717-445-0511 (fax)
sales@raytecllc.com
www.RaytecLLC.com

Raytec has been serving the rain gutter industry since 1956. Manufacturers of Hangtite and Hangfast hidden gutter hangers, the company is committed to exceed your quality and customer service expectations. East Coast, Midwest and Northwest warehouses ensure fast deliveries. Most orders ship in 24 hours.

**Reflective Insulation Manufacturers
Association-International**

PO Box 14174
Lenexa, KS 66285
800-279-4123 (US Only)
785-424-7115 (phone/fax) (fax)
rima@rima.net
www.rimainternational.org

Remodeling Show

PO Box 612128
Dallas, TX 75261-2128
972-536-6466
help@remodelingdeck.com
www.remodelingdeck.com
The 2020 event will be held in at the Baltimore Convention Center in Maryland.

Rockwell Automation, Inc.

1201 South Second St.
Milwaukee, WI 53204-2496
414-382-2000
888-382-1583
414-382-4444 (fax)
webmaster@rockwellautomation.com
www.rockwellautomation.com



Roll Former Corporation

140 Independence Ln.
Chalfont, PA 18914
215-997-2511
215-997-5544 (fax)
jdumke@rollformercorp.com
www.rollformercorp.com
Roll Former Corporation offers the most productive and cost effective roll forming equipment for the metal roofing and architectural sheet metal industries. Since 1978 we have been leading the industry with our innovation and service.



Rollforming Magazine

PO Box 255
Iola, WI 54945
715-252-6360 (Gary)
sharon@shieldwallmedia.com
www.constructionmagnet.com
From the publishers of Rural Builder, Metal Roofing Magazine and Frame Building News. Launched in Fall 2018, Rollforming Magazine is the only publication specifically geared to roll formers in the construction industry. The magazine mails four times annually: Winter, Spring, Summer and Fall. For advertising opportunities contact Gary@shieldwallmedia.com. For editorial questions contact Sharon@shieldwallmedia.com.



RoofTopGuard SA

805 W. 5th St., Unit 10A
Landsdale, PA 19446
267-263-2308
267-263-2389 (fax)
sal@uspnderlayment.com
www.uspnderlayment.com
RoofTopGuard SA™ Ice & Water Protector is our premier, self-adhering, synthetic based, high-temperature roofing

underlayment. At 59" wide, you get quicker coverage; a 20° F-260° F service range; a 5" selvage edge (ideal for valleys); for use under all roofing claddings, yet weighing only 56 lbs.

Rural Builder

Rural Builder

PO Box 255
Iola, WI 54945
715-252-6360 (Gary)
www.constructionmagnet.com
Rural Builder provides the news, features, products and how-to's geared towards builders and suppliers of primarily low-rise agricultural, small retail, municipal and residential structures. Published eight times annually, Rural Builder serves a horizontal market targeting all types of low-rise construction in cities of 250,000 or less population. For editorial questions contact karen@shieldwallmedia.com. For advertising opportunities contact gary@shieldwallmedia.com.



RUSTGO Mobile Work Platforms

405 Valley Lake Dr.
Birmingham, AL 35206
800-448-4077
205-838-8441 (fax)
williamking@rustgousa.com
www.rustgousa.com

We have been the National and International Representative for RUSTGO All-Terrain Mobile Work Platforms for more than 30 years. We are Rustgo Product Specialists in Rustgo Unit sales as well as Rustgo Parts Sales.

S-5! Attachment Solutions

8750 Walker Rd.
Colorado Springs, CO 80908
888-825-3432
719-495-0045 (fax)
info@s-5.com
www.s-5.com



SFS

1045 Spring St.
Wyomissing, PA 19610
610-376-5751
610-376-8551 (fax)
us.construction@sfsintec.biz
www.sfsintecusa.com



Sharkskin Roof Underlayment

1464 Madera Rd.
#N Suite 387,
Simi Valley, CA, 93065
877-742-7507 (Ph); 805-526-1116
(Fax); info@sharkskinroof.com
www.sharkskinroof.com
Sharkskin provides a high strength moisture protective covering by combining a number of key performance features to create a revolutionary line of roofing, building envelope, air/water vapor barrier products, and energy saving roofing systems. The Sharkskin Ultra Radiant® underlayment, in 5-square-foot rolls, is designed for use under metal, tile, and slate roofing systems.



Sheffield Metals International

5467 Evergreen Parkway
Sheffield Village, OH 44054
440-934-8500
440-934-8506 (fax)
marketing@sheffieldmetals.com
www.sheffieldmetals.com
Sheffield Metals is a leader in the manufacturing and distribution of coated and bare metal products. The company specializes in providing pre-painted Galvalume® and aluminum, as well as copper, zinc and stainless steel for the architectural metal panel industry. More than 50 colors are continuously stocked. Sheffield Metals also has a Technical Department offering full services in both testing and engineering. Additionally, the company provides New Tech roll-forming machines and a full line of roofing accessories.



Sherwin-Williams Coil Coatings

1101 S 3rd St.
Minneapolis, MN 55415
888-306-2645
coilhelp@sherwin.com
www.sherwin.com
Sherwin-Williams Coil Coatings (formerly Valspar) has been a leader in the art and science of coatings that excel in both beauty and function. Our expansive range of superior coatings comes to life through a full palette of colors and textures to meet the most demanding environmental requirements, conditions and designs.

Snap-Z, Glick Metals LLC

330 Swamp Rd.
Cliff Stoltzfoos
Morgantown, PA 19543
717-572-0910
888-696-4457 (fax)
info@standingseamroofvent.com
www.standingseamroofvent.com



Source Book, The

PO Box 255
Iola, WI 54945
715-252-6360 (Gary)
715-252-6360 (Gary)
715-252-6360 (Gary)
715-252-6360
gary@shieldwallmedia.com
www.constructionmagnet.com
Cutting edge ideas and inspiration for rural builders. For editorial questions contact karen@shieldwallmedia.com. For advertising opportunities contact gary@shieldwallmedia.com.



Southern Tool and Supply

382 Roy North Rd.
Carrollton, GA 30117
770-832-0207
770-832-0207 (fax)
bill@southern toolandsupply.com
www.southern toolandsupply.com
Please visit our web site or contact us for any roofing tools and supplies that you might need. We stock all types of hard-to-find tools and supplies for installing metal roofing, gutters, sheet metal, slate roofing, and much more. We offer same-day shipping on most in-stock items.



ST Fastening Systems

6357 Reynolds Rd.
Tyler, TX 75708
800-352-4864
800-352-3940 (fax)
dave.quehl@hillmangroup.com
www.stfasteningsystems.com
ST FASTENING SYSTEMS manufactures steel-frame and post-frame fasteners for agricultural, industrial, commercial and residential metal roof and sidewall applications. Product strengths are drill point quality and corrosion resistance, as shown by the WOODBINDER MB drill point and ZXL zinc-aluminum alloy molded head. Both are enhanced by a powder coating paint system. Solid and vented closure strip systems, pipe flashings and other accessories round out the product line.



Swenson Shear

4257 E. Keyes Rd.
Ceres, CA 95307
877-588-8748
209-667-8427 (fax)
sales@swensonshear.com
www.swensonshear.com

Swenson Shear is the number one international provider of metal roof cutting tools and a proud manufacturer of the SnapTable Pro. This all-in-one panel preparation system consistently notches, cuts and produces quality hems for standing seam profiles from 12" -24" and up to 60" offsets for hip and valley roofing cuts.

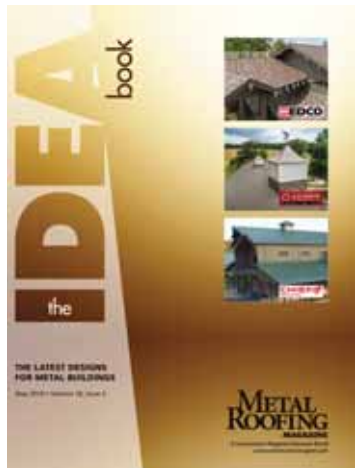

The Idea Book

PO Box 255
PO Box 255
lola, WI 54945
715-252-6360 (Gary)
www.constructionmagnet.com

Featuring signature projects of the metal roofing manufacturers that showcase the best of metal design and architecture. For editorial questions contact Sharon@shieldwallmedia.com. For advertising opportunities contact Gary@shieldwallmedia.com

TITANIUM®

SYNTHETIC ROOFING UNDERLAYMENT

Titanium Synthetic Roof Underlayment

One Owens Corning Parkway
Toledo, OH 43659
800-567-9727
info@owenscorning.com
www.choosetitanium.com

Titanium Synthetic Underlayment. The premium choice for protection that lasts. Contractors trust Titanium for roofing projects that demand performance. Sure-Foot™ Technology creates a safer nodular walking surface that resists tearing and



keeps working to help prevent moisture damage and cracking under tough conditions. Choose one of the most preferred premium synthetic underlayment brands-and the ideal choice for asphalt and metal roofing systems.

Topps Products, Inc.

PO Box 515
Stilwell, KS 66085-0515
913-685-2500
913-851-9700 (fax)
support@toppsproducts.com
www.toppsproducts.com



Triangle Fastener

1925 Preble Ave.
Pittsburgh, PA 15233
800-486-1832
412-321-7838 (fax)
sales@trianglefastener.com
www.trianglefastener.com

TFC has been supplying a full line of fasteners, sealants, tools, and accessories for the commercial construction industry since 1977. From our 23 locations and 7 paint shops, we specialize in high performance standard and specialty products used in a wide range of roofing applications. We offer jobsite and technical support, inventory management, and delivery programs. Select from a wide array of popular commercial-grade products including our high performance TFC SPECIFIC™ brands that provide easy installation, assuring low in-place costs.



United Steel Supply

248 Addie Roy Road, Ste C200
Austin, TX 78746
512-263-0954
512-263-0961 (fax)
sales@unitedsteelsupply.com
www.unitedsteelsupply.com

United Steel Supply furnishes Galvalume, galvanized and pre-painted steel coil for metal roofing and siding applications to the agricultural, commercial, industrial and residential markets, both domestically and for export.

Van Mark Products, Corp.

24145 Industrial Park Dr.
Farmington Hills, MI 48335
800-826-6275
888-826-6275 (fax)
sales@van-mark.com
www.van-mark.com

Varco Pruden Buildings

3200 Players Club Circle
Memphis, TN 38125
901-748-8000
901-748-9323 (fax)
sales@vp.com
www.vp.com



Ventco

115 Lismore Ave.
Glenside, PA 19038
800-300-9515
215-887-7975 (fax)
mrotter@ventcoinc.com
www.shear-x.com

The Revolutionary Ventilation System for Commercial and Residential Metal Roofs. Built on proven technology since 1998, our specially-designed equipment precisely cuts the panel profile into the surface. Working at optimum performance within varied roof pitches from 2:12 to 20:12, ProfileVent is custom cut to fit the individual panel profile. ProfileVent's compatibility with a steep roof pitch makes it uniquely suitable for these applications, without sacrificing ventilation performance. Maintain the ridge line appearance without the need to raise the ridge cap to accommodate the vent.



Viking Equipment Finance

5900 S. Lake Forest Drive, Suite 300
McKinney, TX 75070
612-642-1888
info@vikingequipmentfinance.com
www.vikingequipmentfinance.com

Wrisco Industries Inc.

355 Hiatt Dr. Ste B
Palm Beach Gardens, FL 33418
800-627-2646
561-627-3574 (fax)
sales.staff@wrisco.com
www.wrisco.com



Zimmerman Metals, Inc.

201 E. 58th Ave.
Denver, CO 80216
800-247-4202
303-292-5013 (fax)
brucep@zimmerman-metals.com
www.zimmerman-metals.com

Zimmerman has been in the business for more than 75 years and built a reputation of providing top quality products and excellent service. Our roll formers illustrate this commitment.



PRODUCT PROFILES

Selected products and services for the metal roofing industry.



PHOTO COURTESY OF EVERLAST ROOFING

THE FOLLOWING PAGES OF THIS YEAR'S METAL ROOFING BUYERS' GUIDE FEATURES PRODUCTS THAT METAL ROOFERS NEED FOR GETTING THE JOB DONE.

Each listing is provided by the suppliers themselves and include product information and a snapshot of the product, plus a website address, phone number or e-mail address

where you can find additional information.

Categories are listed alphabetically in the table of contents below, and in the following pages.

Whether you are looking for metal panel, components, or coil, these suppliers are there to help you.

TABLE OF CONTENTS

- | | | | |
|-----------|--|-----------|--|
| 26 | Coil & Coil Coatings | 34 | Roofing Components
(cupolas, rain management, snow & ice management, skylights, solar, software) |
| 27 | Equipment & Jobsite Tools
(roll formers, hand tools, safety equipment) | 37 | Roofing Panel - Standing Seam |
| 30 | Fasteners & Sealers | 39 | Roofing Panel - Metal Shingles |
| 32 | Insulation | 40 | Underlayment |
| 33 | Retrofit & Recoatings | 41 | Ventilation & Condensation Control |

COIL & COIL COATINGS

Sherwin-Williams Coil Coatings



Sherwin-Williams Coil Coating, formerly Valspar, offers a full range of high-performance architectural metal coatings in PVDF, SMP and polyester formulas. Fluoron is its flagship coating, containing 70 percent PVDF resins, and offering premium protection against harmful UV rays, chalk, fade, and chemical degradation. WeatherXL, the next generation enhanced silicone polyester coating, offers protection against weathering for years to come. WeatherXL Crinkle Finish coating offers a unique textured appearance. Each is extremely durable and have excellent film integrity and adhesion properties.

www.coil.sherwin.com

Prassas Metal Products Inc.



PMP Steel is a 29-year-old steel trading and coated coil distributor, specializing in pre-painted Galvalume coil intended for a variety of industry applications; including residential roofing, metal buildings, roll-up and garage doors. PMP Steel maintains coil distribution centers at Savannah, GA and Tampa, FL. PMP Steel stocks ValsparXL, Akzo1050, Generic SMP-Cool PPGL, 29 ga x Regular Polyester PPGL, and Acrylic Galvalume (29 ga – 22 ga) in a wide range of widths. Visit online or call 800-294-3427.

www.pmpsteel.com

Akzo Nobel



AkzoNobel manufactures high-performance coatings to meet the needs of the metal construction industry. Our products include TRINAR, a 70 percent PVDF coating, and CERAM-A-STAR 1050, the benchmark of SMP paint systems. Both products are available in our Cool Chemistry formulations, which help make projects more energy efficient and sustainable. AkzoNobel coatings are widely specified for their excellent performance and durability, as well as their color and gloss retention.

www.akzonobel.com

Contractors...
now you can perforate your AG Panels AND FLAT STOCK with the AG PANEL PERFORATOR!

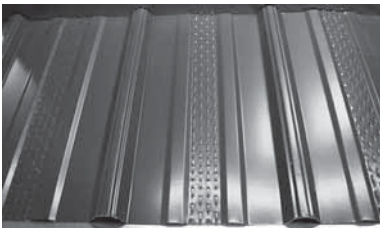
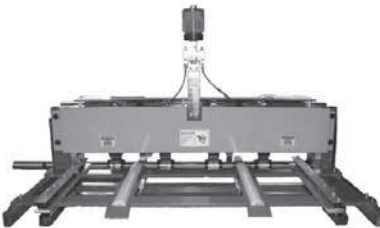

- HD Electric - Gearbox Drive
- Four (4) Sets of Perf Dies
- 29 - 26 ga. Steel for AG Panels
- 29 - 24 ga. Steel, .032" Aluminum - Flat Stock

ROLL FORMER CORPORATION

Call us today at 215-997-2511
www.rollformercorp.com



SHARE YOUR POSITIVE PRESS WITH A REPRINT TODAY!

Let us help you showcase your article by creating high-quality reprints. Positive press like this should be shared to maximize your company's exposure. Use your reprint for endless marketing opportunities such as trade show literature, press kits, direct mail and post a digital copy on your website. Include your company logo and contact information.

FOR A CUSTOM REPRINT QUOTE CALL

Gary Reichert
gary@shieldwallmedia.com
715-252-6360

Dura Coat Products



Dura Coat Products offers two high-performance coil coatings. Durapon 70 is a PVDF formulation with exceptional durability and fade resistance that is also available with thick film primer for tougher environments. Ceramel XT40 SMP is a polymer that is harder, yet more flexible than ordinary coatings. Both are Energy Star compliant.

www.duracoatproducts.com

EQUIPMENT & JOBSITE TOOLS

The Bradbury Co. Inc.



The B.O.S.S. Series, manufactured by Bradbury, is a closed-loop servo shear with speeds up to 300FPM (90 mpm) and accuracy of 1/16" (1.5 mm). The B.O.S.S. can be closed coupled to a new or existing roll-former. The B.O.S.S. is the leader in high-production panel line roll forming.

www.bradburygroup.com

ASC Machine Tools



For more than 70 years ASC Machine Tools, Inc. has been working together with the Metal Building Industry and developed a reputation for innovation, high quality and responsiveness in the design of Metal Wall and Roof Panel Lines. We are proud to offer multiple custom designed Panel Roll-forming Lines with speeds from 150 to 400 FPM.

www.ascmt.com

Acu-Form

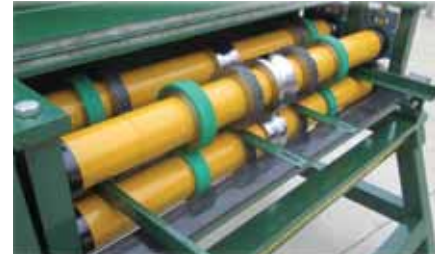

Deluxe Perforator double pass has profiled center dies to hold material and makes a nice straight perforation. All the perforator dies are designed with D2 steel for longer wear life, as well as the ability to sharpen if the need arises. The dual-entry guides can be adjusted to run flat strips for trim pieces. This machine can be powered by electric, hydraulic or mechanical systems.

acu-form@safecommail.com

Englert Inc.



The Englert MetalMan FP1300 Panel Rollformer is a state-of-the-art roll-forming machine that runs the A1300 Panel in various gauges and types of materials with minimal adjustment and less scrap. On-site fabrication eliminates shipping damage and short shipments while reducing sizing errors and providing packaging and freight savings. Available in 16-inch and 20-inch coverage. Financing available.

www.englertinc.com

Marion Manufacturing



Marion Manufacturing adds value to the metal. Marion Manufacturing designs, fabricates and installs custom manufacturing and production machinery. Marion specializes in metal-forming equipment such as: roll formers, uncoilers, shears, stackers, etc. Marion Manufacturing also offers a full-service machine shop and re-tooling/service on other brands of equipment.

www.marionmanufacturing.com

Hershey's Metal Meister, LLC



Variobend USA is where service and long-term relationships are a way of life, not just a sales pitch. Variobend USA folding machines are assembled from the ground up in Illinois, with all the electrical, hydraulic, software, and an increasing amount of manufacturing done in-house. This assures that the resources are nearby to keep your investment running at peak performance. Stay tuned for revolutionary innovations hitting the market soon!

Info@HersheysMM.com

EQUIPMENT & JOBSITE TOOLS

Roll Former Corporation



Roll Former Corporation's VS-150 Machine is the company's most versatile multiple-profile machine forming 1" and 1-½" standing seam profiles—complete with hydraulic drive and shear as well as adjustable panel width of 9" to 24". The VS-150 is offered with Optional Panel Dies, giving the contractor up to eight (8) different profiles including Snap Lock and "True Board & Batten" Panel and Cap profiles. All of this with quick and easy changeover! Call us today at 215-997-2511.

www.rollformercorp.com

Metal Rollforming Systems



Metal Rollforming Systems (MRS) designs and manufactures industry-leading roll-forming equipment and accessories. Our complete in-house design and manufacturing facility allows us to price the equipment at a very competitive price, making us a leader in roll-forming equipment manufacturing. MRS' product lines consist of single- and double-deck roll formers, single- and multi-trim roll formers, slitters, sheet stackers, and much more. Metal Rollforming Systems takes great pride in our customer support both before and after the sale.

www.mrsrollform.com

New Tech Machinery



The newly configured NTM SSQ II™ Roof Panel Machine is the original, best-selling SSQ, but now with added functionalities to make it the most versatile machine available. New features include notching capabilities: notches (square and profiled) are punched before the legs are formed for a cleaner cut; angled slitting; allows panel cutting at any angle from 90-35 degrees; NTM200 Controller; and specialty profiles. The SSQ II comes with 15 quick-change profile options, 45 minutes or less tooling changes, and one of the industry's best warranties.

www.newtechmachinery.com

GutterSupply.com



GutterSupply.com is your partner for roll-forming machines. We specialize in Metal Roof Panel Machines and Gutter Machines. We offer the industry's lowest pricing, as well as additional credits back for factory training. Our customers can customize their machines to fit their needs or buy the complete package for additional savings. Contact us today to find out which machine best suits your needs, and ask about our financing options.

www.guttersupply.com

Swenson Shear



Swenson Shear manufactures tools for the metal roofing industry. Swenson offers its SnapTable Pro, an all-in-one panel preparation tool with notching, cutting, and hemming capabilities for standing seam. Each component can also be purchased separately. Swenson's newest editions are the Cut Master, which provides consistent notches/cuts and the Eave Master, which notches/hems leading and trailing edges. Swenson's original shears are a must-have for exposed fastener profiles. Additionally, Swenson offers Stone Coat tools.

www.swensonshear.com

Zimmerman Metals



Zimmerman Metals manufactures a premier line of U.S.-made machines that roll form standing seam roof and wall panels. Panels are formed from aluminum, copper, and steel for architectural, commercial, residential, and structural applications. Inplant or portable models. Zimmerman also has the Quick Span Arch Building Machine to manufacture arch steel buildings on site. Quality workmanship and service since 1936.

www.zimmerman-metals.com

John Stortz & Son, Inc.



The AccuSeamer is a drill attachment for seaming 90 degree and 180 degree mechanical locking panel systems. The AccuSeamer's lightweight and durable construction turns your shop drill into a power seamer. For 1" and 1.5" seam heights, the AccuSeamer is one-third the cost and one-fourth the weight of a traditional power seamer while moving at 180 feet per minute. Avoid the time-consuming nature of hand locking panel lengths as well as lugging a heavy power seamer to the rooftop.

jeff@stortz.com

Southern Tools & Supply



Southern Tool and Supply has all your hard-to-find hand tools and supplies for metal roofing. Best of all we ship direct to your door, no driving all over town looking and wasting time and money. We usually ship the same day with in-stock items. Just give us a call at 678-890-1238 or visit our on-line store.

www.southerntoolandsupply.com

Dynamic Fastener



Dynamic Fastener offers a variety of professional tools by DeWalt, Milwaukee, Bosch, Hitachi, Fein, Trumpf, Olympic, Makita, Metabo, Skilsaw and Kett Power Tools, as well as Klein, Proto and Crescent Tools, bolt bags and leather goods. Also offered are DBI Sala, Preferred Safety and Guardian fall protection; plus hard hats, safety glasses, and hearing protection. Same-day shipping is available for screws, anchors, flashings, safety equipment, hand tools, and power tools. A free 140-page, full color, tool and fastener handguide provides engineering data, and details product offering.

www.dynamicfastener.com

SAFETY EQUIPMENT

Rustgo



The Rustgo Mobile Work Platform models allow up to six workers, on three levels at varied heights, multiply their effectiveness as they roll down the side of your job. No scaffolding. No CDL driver needed. No trailer needed. No motors to maintain. Super low maintenance. Just tow the Rustgo behind your truck to your job site. There is no better tool for reaching your goals and cutting costs. Made in the U.S.A.

www.rustgousa.com

Metal Plus LLC



Metal Plus continues to expand its dependable product line of Standing Seam Metal Roofing Brackets with the introduction of the Universal Safety Anchor (USA)! The name Universal Safety Anchor, and its innovative design, implies exactly what it's capable of doing. It is able to accommodate multiple panels with no loose components or set screws that gouge panels like the anchors now currently available to the industry. The Metal Plus Universal Safety Anchor is not only user friendly but makes replacement parts a thing of the past.

www.metalplusllc.com

UPCOMING ISSUES
METAL ROOFING
MAGAZINE

FEBRUARY/MARCH 2020

- **Cover Story:** State of the Industry
- **Top Products of 2019**
- **Show Preview:** International Roofing Expo Preview
- **Gutter Feature:** Company Profile
- **Product Feature/Profiles:** Machines/ Roll Formers/Gutter Machines
- **Project of the Month**
- **Poll Question**
- **Bonus Distribution:** International Roofing Expo
- **Advertising Deadline:** December 27, 2019



SUBSCRIBE:
www.constructionmagnet.com/subscribe
or see the subscription card in this issue

ADVERTISING:
Gary Reichert
gary@shieldwallmedia.com • 715-252-6360

EDITORIAL:
Sharon Thatcher
sharon@shieldwallmedia.com • 715-257-4197

FASTENERS & SEALANTS

SFS



SFS is a premier manufacturer of fasteners for metal construction offering carbon steel, bi-metal and stainless steel self-drill fasteners in a variety of diameters, thread designs, head styles and drill points to meet the demands of metal building and commercial construction requirements. SFS manufactures snap lock, fixed and float panel clips for standing seam roof applications, as well as a complete line of fasteners specific for clip attachment to substrate. Accessories include VistaFoam® closure, VistaVent® panel fit and universal venting material, pipe flashings, and sealant tape.

www.sfsintecusa.com

Dynamic Fastener



Dynamic Fasteners offers a variety of specialized fasteners, including the D.F. brand self-drilling screws made for stitching and sheet-to-structural applications; pole-barn fasteners for attaching up to 18-gauge sheet metal-to-wood; and clip screws that require a low-clearance head when fastening to steel or wood. Fasteners are available in stainless steel and with the Dyna-Coat 1,000-hour salt spray premium coating.

www.dynamicfastener.com

East Coast Fasteners



East Coast Fasteners produces durable fasteners for all combinations of building materials. The Ply-Lo Extreme line of fasteners is designed for extreme environments. The Ply-Lo Driller is the latest innovative addition to the company's fastener line, designed to save contractors time and money. The Ply-Lo Driller features a patent-pending design intended to be more forgiving than other fasteners. This means the tip is designed to reduce the likelihood of "walking" when fasteners are driven at a slight angle. Less walking means quicker and easier installation as well as a reduction in material damage and waste. The Ply-Lo Driller is available in colors to match virtually any panel as a #10 fastener in lengths of 1, 1-1/2, 2, 2-1/2, and 3 inches.

www.plyco.com

Atlas Bolt & Screw



AccuDRYve System Technology includes a screw gun and fastener that automatically stops driving the fastener when properly seated for a leak-proof seal. The fastener washer is engineered to deflect with proper force to disengage the clutch and stop driving the fastener. Dual-thread design prevents metal from panel extruding up, cutting the washer, and ensuring that the metal panel is flush to the substrate before seating. AccuDRYve provides the perfect seal by everybody every time.

www.atlasfasteners.com

BECK America



The RoofLoc® SCRAIL® system was developed to install metal roofing and facades quickly and efficiently. Two times faster than collated screws, and eight times faster than bulk screws, this performance could only be achieved through the combination of the pneumatic Roofing Installation Tool and the patented RoofLoc® SCRAIL®. The tool design allows for excellent ergonomics and tool balance, which promotes better ease of use, even on the longest, toughest jobs.

www.beck-america.com

Leland Industries



"Mini Drill Point" roofing and siding screws feature a self-drilling "Mini Point" to reduce installer fatigue when drilling in extended arm positions. Featuring a Hi-Hex head to compliment the Mini Drill point, the fastener drills and taps high-tensile steel with ease and is capable of drilling 16-gauge total thickness. Available in Low Profile Truss head design or Hi-Hex, Mini Drills are used for attaching metal sheets to metal door frames or multiple laps of steel sheet. The product drills with no pig tails and at speeds as low as 1,000 RPM. Offered in Carbon or high-tensile Stainless Steel, the MDP screw can be powder coated and warranted to match long-life panel warranties.

www.lelandindustries.com

ST Fastening Systems



ST Fastening Systems supplies steel-frame and post-frame screws for agricultural, commercial, industrial, and residential metal roof applications. Product strengths are drill quality and corrosion resistance, enhanced by the state-of-the-art POWDERFUL powder coat paint. The MAXX Steelbinder and Woodbinder MB with micro-bit drill point eliminates slow-drill or no-drill complaints. The ZXL Steelbinder and Woodbinder is a zinc-aluminum alloy molded head family that carries a 40-year warranty against red rust. New in 2019 is the Woodbinder OSB sharp point Type 17 specifically designed to prevent strip-out in OSB and light-density wood. It is also available in a ZXL version for residential metal roofs.

www.stfasteningsystems.com

Titebond



Titebond WeatherMaster Metal Roof Sealant is specifically formulated to outperform all other sealant technologies, including silicones, tri-polymers and polyurethanes. This superior polymer provides a waterproof seal against water, wind, dust and dirt. It offers exceptional adhesion to Kynar-coated metal materials, along with standard metal, aluminum, steel, galvanized bonderized surfaces, plastics, and glass. Titebond WeatherMaster Metal Roof Sealant is available in over 50 colors, all of which match today's popular metal roof and metal siding colors, regardless of the material or manufacturer.

www.dynamicfastener.com

Building Products Development

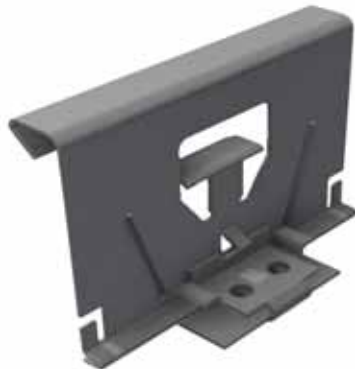

Building Products Development (BPD) is a leading metal roof clip manufacturer in the United States. BPD offers a full line of high-quality clips and accessories for all standing seam profiles. With large stock readily available, BPD is able to process and ship most orders on the same day.

www.wegotclips.com

Triangle Fastener Corporation



TFC is pleased to announce the #14 DP1 CONCEALOR® 304 Stainless Steel Bi-Metal Pancake Head Screw. The new screw is engineered to provide superior corrosion resistance and ductility. It is dimensionally identical to the #14-13 DP1 carbon steel CONCEALOR,® providing easy installation. The buttress thread increases pullout loads compared to ordinary roofing screws. It is TRI-SEAL® top-coated to improve tapping and reduce thread roll-over. It can be used to fasten to metal, wood, or concrete.

www.trianglefastener.com

Maze Nails



Maze is the exclusive manufacturer of Stormguard double hot-dipped galvanized nails with a lifetime warranty against rust. In business since 1848, Maze offers a full line of specialty nails in bulk for hand driving and in collated sticks and coils for popular pneumatic nailers. Maze has been serving the post-frame industry for many years, providing painted rubber washer nails for corrugated roofing and siding. Maze post-frame nails meet the all-important ASTM F 1667 specification. In addition, Maze manufactures nails for fiber cement siding products, cedar and redwood sidings, fencing, decking and roofing. Maze nails are proudly made in the USA in Peru, Illinois.

www.mazenails.com

UPCOMING ISSUES

ROLLFORMING MAGAZINE

SPRING 2020

- **Cover Story:** Help diversify your business with custom panels
- **Secondary Article:** What determines the thickness or type of metal in any given application?
- **Product Profiles:** Snips, Shears, Seamers
- **Roll-former Company Feature**
- **Bonus Distribution:** Florida Roofing & Sheet Metal Expo & Western Roofing Expo
- **Advertising Deadline:** April 24, 2020
- **Issue Mailing Date:** May

SUBSCRIBE:

www.constructionmagnet.com/subscribe
or see the subscription card in this issue

ADVERTISING:

Gary Reichert
gary@shieldwallmedia.com • 715-252-6360

EDITORIAL:

Sharon Thatcher
sharon@shieldwallmedia.com • 715-257-4197

INSULATION

NOFP



Northwestern Ohio Foam Products manufactures high-performance insulation for the agricultural, residential, commercial, and industrial construction markets. MicroFoil, Solex and Performance Star lines of reflective material are high-quality products offering outstanding features and benefits, including multiple options and R-Values for all your building needs. The Barrier Radiant Floor Under Slab Insulation provides an ideal solution for radiant-heated slab projects.

www.nofp.com

MWI Components



MWI is here to bring you a technologically-advanced insulation material ideal for new construction or retrofit installation in residential, commercial, industrial, metal and post-frame buildings. With outstanding thermal performance, easy installation, versatility, price and environmental friendliness, TempShield™ is sure to impress. This foil insulation product reflects 94% of radiant energy, doesn't promote nesting of insects or rodents, won't compress, collapse or disintegrate and is extensively tested. Find out more on the MWI website!

www.mwicomponents.com

rFOIL/Coverttech



rFOIL-2600 series is designed to control heat gain/loss in all types of post-frame buildings. It blocks 96 percent of radiant heat transfer, is guaranteed not to delaminate, crack, peel or flake; and carries an unmatched 10 YEAR guarantee on material and labor. rFoil contains UV inhibitors and anti-oxidants for long-term durability, is tested to ASTM G-155 for UV resistance and facing surface degradation, has better thermal value and condensation control than fiber glass insulation, and boasts a class 1/A Fire Rating and passes the NFPA-286 full room burn test.

www.rfoil.com



A. B. MARTIN
ROOFING SUPPLY, LLC

Roofing & Siding • Hardware • Lumber

**BUY DIRECT FROM THE
MANUFACTURER AND SAVE!**



ABSeam PANEL

24 GAUGE STEEL - ALWAYS MEASURED BEFORE THE PAINT
OVER 16 COLORS WITH 40-YEAR WARRANTIES



ABM PANEL

28 GAUGE STEEL - ALWAYS MEASURED BEFORE THE PAINT
OVER 25 COLORS WITH 40-YEAR WARRANTIES
MADE TO CUSTOM LENGTHS



82 Garden Spot Rd. | Ephrata, PA 17522 | 717-445-6885
35 Ridge Rd. | Newville, PA 17241 | 717-776-5951 www.abmartin.net

It's all about the **CLIPS**
Providing standing seam clips for metal roofing.

Providing quality clips and accessories for:

Knudson	Englert
Rollformer	Quadra-Pro™
Schlebach	New Tech
Ultra Seam	Zimmerman

866-766-3254
WeGotClips.com

bpd

LSI GROUP
METAL BUILDING COMPONENTS
Legal Stampings - BFD - Roof Hopper

RETROFIT & RECOATINGS

Roof Hugger, LLC

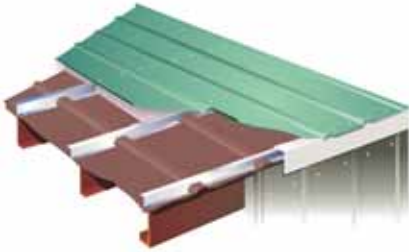

Roof Huggers are 10' long, tested, high strength, structurally correct, 16 ga., 0.060" min., G-90, 50 ksi, "Z" shaped sub-purlins, specifically notched to let the ribs of any existing metal panel pass through the vertical leg of the "Z". This unique retrofit system allows any new metal roof to be installed over an existing metal roof without its removal, saving time, money and allowing for thermal upgrading of the existing building.

www.roofhugger.com

EPDM Coatings



Fix Roof Leaks Once With the Only LIQUID EPDM Rubber in the World! Over a 25-year history of success. This catalyst-based one-coat system has a unique curing process allowing for cross-linking to occur, creating a chemical bond to the substrate it is applied on. It waterproofs immediately and can withstand ponding water 365 days a year. Liquid EPDM Rubber will take temperatures from -60 to 300 F degrees. It is UV and Ozone resistant and has proven itself superior to acrylics, urethanes and other elastomers for up to four times longer. To get your sales packet and volume pricing, visit the website.

www.epdmcoatings.com

Nationwide Protective Coating Mfrs.



The PERMAGARD® Roof Coating System is a waterproofing acrylic, insulating ceramic protective Elastomeric Roof Coating System. PERMAGARD® is an Energy Star-certified coating providing many benefits to a property owner including the ability to refinish and restore, even completely covered rusted roofs with a coating, eliminating the need to re-roof and the cost and mess associated with it. PERMAGARD® will stand up to the harshest conditions and provide cost effective solutions for years to come, make PERMAGARD® the go-to waterproofing coating for new or old metal roofs!

www.roofcoatings.net

Dynamic Fastener



Drop-Stop sealer was specifically designed for application to metal roofs and problem areas such as gutters, expansion joints, etc. Drop-Stop can easily be applied over sloped, contoured surfaces and will give long-lasting, colorful protection. Made from select synthetic rubbers, Drop-Stop is applied effortlessly as heavy-bodied paints. This unique material actually stretches and recovers to bridge roof joints in which thermal movement can be expected. With 1500 PSI tensile strength and 600 percent elongation capabilities, Drop-Stop can single-handedly tackle most metal repairs. White Drop-Stop is stocked in 20 oz. sausage packs, one gallon pails, five gallon buckets and 55 gallon drums.

www.dynamicfastener.com

EMAIL YOUR INFORMATION TO OUR READERS

- **REACH:** Rural Builder, Frame Building News, Metal Roofing, Rollforming Magazine Readers
- **TIMING:** Send when you want to coordinate with product releases, special events or trade shows
- **RESPONSE:** Prospects can click on the ad and respond to you immediately
- **ACCOUNTABILITY:** You get a report showing how many readers received, opened and clicked on your DEBs

CONTACT:

Gary Reichert
gary@shieldwallmedia.com – 715-252-6360



MENTION THIS AD & YOUR SECOND DEB IS HALF PRICE

ROOFING COMPONENTS & SOFTWARE

CUPOLAS

MWI Components



Let's talk icing on the cake! MWI is an industry-leading manufacturer of light-gauge, steel cupolas. Our pre-painted, 29-gauge constructed cupolas are available in 100+ standard colors plus Kynar. All metal edges are hemmed, and there's no need to worry about red rust! Our cupolas' roof and sides interlock for a weather-tight connection. The 24", 36", and 48" cupolas ship knocked down, while 66" and octagon cupolas ship assembled. Find the icing for YOUR cake at MWI!

www.mwicomponents.com

AG-CO



Cupolas by AG-CO are easy to install (only three pieces, including weathervane), low maintenance and economical. The cupolas come in 13 different top colors, 13 bottom section colors and 15 different weathervanes. With thousands of combinations, your customers are sure to get a unique and attractive addition to their building!

www.ag-co.com

Plyco



Plyco Corporation's line of cupolas, available in two-foot, three-foot and four-foot sizes, add a finished accent to any building project along with ventilation control. Featuring sides with louvers or windows, the cupolas can be constructed with flat or curved roofs, in colors that match most industry options. Designed to assemble quickly on the jobsite, Plyco cupolas have a premium base option that eliminates the need to build a wooden base. Cupolas are also offered with a textured finish and a variety of weathervane options.

www.plyco.com

RAIN MANAGEMENT

Advanced Architectural



ADVANCED Architectural continues to manufacture in-house and provides consistent, excellent customer service with their quality gutters, downspouts, elbows and gutter accessories as well as brake metal to roofers and contractors nationally. Their team concept with dedication, quality control and commitment goes above and beyond with every customer. ADVANCED has been serving the industry for over 25 years.

www.advarchsm.com

Midwest Enterprises



Hydroclean® High Capacity gutter guards are engineered for heavy rain volume areas where the perforated surfaces work hard to channel away excess rainwater. Best on long runs of standard shingles, very steep roofs, and metal roofs, the 5-inch guards have three rows of perforations, where guards for 6- and 7-inch gutters have 6 rows – to handle even greater volumes.

www.e-zgutter.com

Raytec Manufacturing



HangTite and HangFast hidden gutter hangers, manufactured by Raytec Manufacturing, are exceptionally strong. Both have proven records of performance, strength and ease of use in the field. Raytec engineers designed the Hangtite to be strong. Hangfast hangers, with the integrated screw, add speed to the installation without compromising performance. Both hangers are available in 5-inch and 6-inch sizes, in aluminum, galvanized, and copper.

www.raytecllc.com

SNOW & ICE MANAGEMENT

Dynamic Fastener



Dynamic Fastener's Dyna-Guard snow retention system is designed to be used on virtually any steel metal roof. Dyna-Guard is an 8-foot long extruded aluminum rail with a T-shape profile. Dyna-Guard is installed by attaching non-ferrous clamps or mounts to a metal roof and bolting or screwing the system to clamps or mounts. Eight Dyna-Clamps with round-point stainless steel set screws and Sno-Dams are also offered. Sno-Dams attach to the back of Dyna-Guard and inhibit snow and ice from sliding underneath. Dyna-Clips are available as a Dyna-Guard to Dyna-Clamp connection device when using unpunched Dyna-Guard. A 2-inch wide painted strip of metal from the same material as the roof is inserted in the Dyna-Guard for aesthetics.

www.dynamicfastener.com

ST Fastening Systems



ST Fastening Systems offers Snow Trax snow retention guards for exposed fastener roofs and the MRC Snow Trax roof clamp for standing seam roofs. The Snow Trax is 16-gauge 304 stainless steel available in more than 20 powder coated colors. Its adhered rubber gasket eliminates the need for additional sealant. The MRC is extruded aluminum, and a colored rail slides through the clamp grooves to provide maximum protection from snow and ice.

www.stfasteningsystems.com

AceClamp by PMC Industries



The AceClamp® Snow Titan™ is our strongest and easiest snap-together snow retention system on the market. The newly designed cantilever "gripping claw" offers the latest in clamping mechanisms for easy installs with confident gripping power. The uniquely-built triangular rail handles extreme snow loads with confidence. Our patented "sliding-pin" designed Ace clamps help protect the panel and warranty and come standard with any of our A2® style Snow Titan™ snow retention systems.

www.aceclamp.com

SNOW & ICE MANAGEMENT

Isaiah Industries



Isaiah Industries' Ice Dam Cutter gets to the root of troublesome ice problems on roofs by cutting vertical relief channels in the snow load, which allow any ponding water to drain off the roof. This easy-to-install system is a very affordable solution to ice dam issues, which can't be addressed by ventilation and insulation. It can be applied to most metal roofs as well as other materials. This system requires no special wiring and includes heat cables for gutters and downspouts. Available in several roof colors.

www.isaiahindustries.com

MWI Components



NATURAL LIGHT can't be understated. When it comes to natural daylight, MWI's Polycarbonate Skylight is perfect for roof or vertical sidelights. Naturally-lit buildings create pleasant, improved environments for livestock. PLUS, they have significantly lower running costs with higher energy efficiency than buildings relying on artificial light. Discover a multitude of profiles in a variety of lengths and colors (clear, opal, soft white, solar gray). MWI's Polycarbonate Skylight: practical, cost efficient, ideal for your next project!

www.mwicomponents.com

SKYLIGHTS

Palram Americas



Palram Americas offers SUNSKY polycarbonate panels for daylighting applications. Palram's proprietary MetalMatch technology allows for rapid matching of existing corrugated metal profiles. As a result, Palram has developed the world's largest catalog of corrugated polycarbonate profiles. SUNSKY profiles feature co-extruded UV protection. In fact, SUNSKY is warranted for 10 years against loss of light transmission due to yellowing, and against damage due to hail.

www.palram.com

ROOFING COMPONENTS & SOFTWARE

SOLAR

AceClamp by PMC Industries



AceClamp®, manufacturer of precision-engineered snow retention and solar mounting systems is setting the bar in solar racking with its most recent innovative product - "Solar Snap." An adaptive solar racking solution, "Solar Snap" is designed to work with any of our SSMR clamps, corrugated brackets, and MCP (Membrane Coated Plate) - making it an ideal solution for almost any roof type. Maintain less inventory with AceClamp.

www.aceclamp.com

SOFTWARE

Paragon Computing



The Paradigm family of software products from Paragon Computing Solutions, LLC provides a complete business management system designed to allow building supply companies and metal manufacturers to efficiently manage their operations. Imagine... a streamlined operation that allows you to seamlessly manage inventory, manufacturing, delivery, and accounting. That's what Paragon Computing Solutions can help you achieve.

www.goparagon.com

AppliCad USA

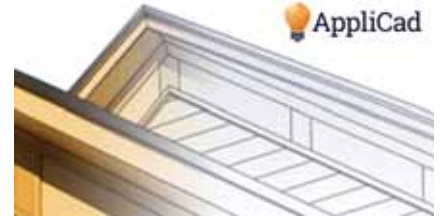

AppliCad has developed software for simplified roof modeling in 3D that results in comprehensive cladding material and labor take-off, client proposals and job planning. The software creates complete material lists, cutting lists, workshop details, supplier orders, and labor summary at the click of a mouse button. With 25+ years experience and software in 148 countries, AppliCad knows how to do estimates for metal roofing and wall cladding, including all associated trim and accessory items.

www.appliacad.com

DON'T REPLACE! DON'T RE-ROOF!

CLASS A FIRE RATING **PERMAKOTE** **CERAMIC INSULATING TECHNOLOGY**

YOUR ROOF!

AN INNOVATIVE WATERPROOFING & INSULATING ROOFING SYSTEM

15 YEAR LIMITED WARRANTY

- Effectively Seals & Prevents Most Leaks
- Space Age Ceramic Insulation
- Saves Up to 40% on Energy Costs
- Environmentally Safe

ENERGY STAR PARTNER
Partner Since 1999

WATERPROOFING • SOUNDPROOFING • INSULATING • BEAUTIFYING • PROTECTING

CALL FOR A FREE PRODUCT CATALOG • ASK ABOUT OUR CUSTOM PRIVATE LABELING PROGRAM

NATIONWIDE PROTECTIVE COATING MFRS., INC.

1.800.423.7264 941.753.7500

ACCREDITED BUSINESS A+ RATING
Member Since 1997

GREEN SAFE

WWW.ROOFCOATINGS.NET

ROOFING PANEL

STANDING SEAM

Metal Panels Inc.



Metal Panels Inc. offers over 19 profiles of quality metal roof and wall panels, all available in durable finishes and energy-saving cool colors. Builders can expect one of the quickest turn-around times in the industry, with project managers on hand to help with custom orders. Exposed and hidden fastener panels, custom trim, accessories, and flat sheets are available from our locations. MPI services a Midwest, seven-state region through our manufacturing centers in Oklahoma and Kansas.

www.metalpanelsinc.com

Morin Corporation

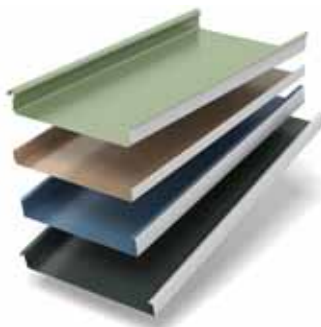

Morin Corporation offers multiple Standing Seam Single Element Metal Roofing Profiles. From a simple Fast Snap-Lock to complex Geometry Architectural Systems, Morin can provide a variety of Solutions to fit your needs. We specialize in Heavier Gauge Architectural Systems, and we leverage unique natural metals like zinc on many projects for lasting durable finishes. With Coast-to-Coast service and On-Site Roll Forming, Morin Roof Systems can fit most any project. #morincorp

www.morincorp.com

Petersen Aluminum



Petersen's SNAP-CLAD metal roofing panels feature architectural panel aesthetics and structural panel performance. SNAP-CLAD panels are available in over 45 colors and in steel and aluminum. The 70 percent PVDF finish is covered by a non-prorated 30-year warranty. Most colors meet LEED®, ENERGY STAR® and cool roof certification requirements. For information about Petersen's full product line, visit PAC-CLAD.com or call 800-PAC-CLAD.

www.PAC-CLAD.com

McElroy Metal



Maxima ADV architectural standing seam roofing system offers mechanically seamed panels, 12-, 16-, 18- or 24-inches wide with a 180-degree fold in a seam height of two inches. Panels are available flat, striated or with pencil ribs and can be formed and curved on site with a PVDF finish. Floating clips allow for 3-1/8 inches of thermal movement.

www.mcelroymetal.com

American Building Components



For builders, prolonging the life of an existing roof without damaging the existing roof can be accomplished with American Building Components' Retro-R metal panel. An economical option that restores and extends the life of any roof, this exposed-fastened panel fits over any existing R-panel roof. Available in 26- or 29-gauge, 36" width panels featuring a 1-1/16" rib height, Retro-R is a cost-efficient, high-quality solution that is also lightweight and durable.

www.abcmetalroofing.com

Graber Post Buildings Inc.



Each panel is coated with Galvalume, a patented aluminum-zinc alloy coating for extra protection. Panels are then bonderized and an Optima Primer is applied. The primer supplies flexibility and provides an excellent base for the final coat of CERAM-A-STAR, a tough and durable two-coat exterior finish. It has a soft look, with a textured coating surface, all while continuing to be tough as nails!

www.graberpost.com

ROOFING PANEL

STANDING SEAM

A.B. Martin Roofing Supply



Do you need an extraordinary look for that special project? Get the Aged Metal rustic panels with a 40-year finish warranty. The dual-coat Kynar finish has been increasingly popular for exterior and interior projects. Made to custom lengths in all of panels – including the 1-1/4-inch and 2-1/2-inch corrugated panels, ABM Panel, and 16-1/2-inch-wide ABSeam Panel. Get inspiration at abmartin.net/aged-metal. Order today!

www.abmartin.net

Everlast Metals



Servicing the architectural community, Everlast Metals is proud of our reputation for uncompromising quality and is a logical choice for those looking for a true partner. Offering high-quality metal, Everlast Metals will meet and exceed all of your UL requirements. Servicing the New England, Mid-Atlantic, and Midwest market, Everlast Metals offers metal roof and wall panel systems in 26- and 24-gauge steel and .032 and .040 aluminum from our 84,000 square foot facility in Lebanon, Pennsylvania. In addition to our Lebanon facility, we have a fully stocked warehouse located inside the Philadelphia market.

www.everlastmetals.com

Everlast Roofing



Everlast Roofing, Inc. understands how essential quality roofing and siding is to your structure. From farm buildings to homes and more, our next generation of metal roofing is created using CECI® and Heat Forming™ and combining it with AZM® and the best paint system on the market. At Everlast Roofing, Inc., we provide reliable steel roofing shaped by our innovative, laboratory-tested technologies.

www.everlastroofing.com

UPCOMING ISSUES RURAL BUILDER

FEBRUARY 2020

- **Frame Building Expo Preview**
- **Top Products of 2019**
- **Cover Story:** State of the Industry
- **Product Profiles/Feature:** New Products at the Expo
- **Feature:** Rules of Order in Committee Meetings
- **Question of the Month**
- **Project of the Month**
- **Advertising Deadline:** January 3, 2020



SUBSCRIBE:

www.constructionmagnet.com/subscribe
or see the subscription card in this issue

ADVERTISING:

Gary Reichert
gary@shieldwallmedia.com • 715-252-6360

EDITORIAL:

Karen Knapstein
karen@shieldwallmedia.com • 715-598-4004

ABC Supply



ABC Supply Co. Inc. is the largest wholesale distributor of roofing in the United States and one of the nation's largest wholesale distributors of select exterior and interior building products. The company carries a broad portfolio of steep- and low-slope roofing materials, insulation, and accessories. This includes products such as asphalt, concrete, clay, slate and composite roof shingles, cedar shakes, metal roofing, single-ply, built-up, modified bitumen roofing and more.

www.abcsupply.com

Fabral



For more than 50 years Fabral has been providing contractors and builders with top-quality building products. This year Fabral introduced new colors, textures, and designs to its portfolio. With an expanded portfolio and dedicated customer service values, Fabral is bound to become the provider of choice.

www.fabral.com

METAL SHINGLES

CertainTeed



Available in three architectural profiles, Matterhorn Metal Roofing by CertainTeed replicates the charm of classic shake, slate and tile with less upkeep and greater longevity and impact resistance. Engineered from high-performance steel and featuring cool roof colors that comply with Title 24 California energy codes, it is the perfect combination of performance and protection. Innovative, sustainable, and award-winning, Matterhorn is an ideal long-term roofing solution for both residential and light-commercial applications.

www.certainteed.com

EDCO Products



Weathered Wood Enhanced



Roadhouse

EDCO Products has introduced two new colors to its award-winning Infiniti Textured Shake roofing. Weathered Wood, with enhanced shadow lines, provides a stunning, genuine wood shake appearance. Roadhouse mimics a weathered rustic steel appearance that is highly desirable for residential roofing and sidewall applications. Our proprietary technology gives the appearance of rust without the degradation of actual rust unlike other rustic metal roofing products. Both products have a 40-year fade protection with a lifetime warranty.

www.edcoproducts.com

Isaiah Industries



Country Manor Shake aluminum roofing is designed for property owners who want a prestigious look combined with rust resistance, lasting durability, and energy efficiency. Fully interlocking panels with concealed fasteners backed by a Lifetime Limited Warranty. Manufactured by Isaiah Industries, home of the industry's shortest lead times and superior customer support.

www.isaiahindustries.com

2" WIDE, 1" THICK
PRO SERIES UNI-VENT™
 USE ON ANY ROOF PITCH FROM 2/12 TO 20/12

- VINYL COATING
- UV STABILIZED/FIRE RETARDANT
- POLYURETHANE FOAM
- CONTINUOUS DOUBLE GLUE STRIP

UNI-VENT™ PRO SERIES

- EASY TO INSTALL; 20' PER ROLL
- USE WITH ANY MANUFACTURER'S RIDGE CAP
- WITHSTANDS 100 MPH WIND-DRIVEN RAIN
- STANDARD 9" OC PROFILE MATCHES ROOFING PROFILE

CRS 309
 CONSTRUCTION ROLLFORMING SYSTEMS

MRS
 METAL ROLLFORMING SYSTEMS

The Affordable Rollforming Equipment Manufacturer

Metal Rollforming Systems designs and manufactures reliable and affordable rollforming equipment and accessories, making us a leader in rollforming equipment manufacturing. Our unsurpassed technical support is unlike any other in the industry, we work until the job is done. Our customer's success is our success. For more information, please contact us at 509.822.8123 or visit us online.

- Single & Double Deck Rollformers
- Trim Rollformers
- "NEW" Patriot Rollforming Line
- Coil Reels
- Precision Cut Slitting Lines
- Sheet Stackers
- Coil Upenders
- Ridge-Cap Press

CRS 201
 CONSTRUCTION ROLLFORMING SYSTEMS

509.822.2123 www.mrsrollform.com

UNDERLAYMENTS

Levi's Building Components



Roloshield 25 and 50: Both contractor-friendly and lightweight, Roloshield is stronger than felt and faster to install. Self-sealing and ideal for use under wood, shingle or metal roofs, it provides long-lasting performance and ease of installation. Use less rolls to cover more roof and lower your installed cost with this 100 percent polypropylene synthetic roofing underlayment. RoloShield lays flat and is water resistant with superior drapability in valleys and on ridges and hips. UV resistance provides installation opportunities on hot sunny days and provides a cooler working surface.

www.levisbuildingcomponents.com

MFM Building Products



Premium HT Wind & Water Seal™ is a self-adhering underlayment composed of a high-grade, reinforced polyester fabric laminated to a high temperature rubberized asphalt adhesive. It is engineered for whole roof coverage under tile and metal roofing systems where extreme heat is generated. The membrane is self-sealing around fasteners and has a slip-resistant surface. The 60 mil underlayment comes in a 36" x 67' roll size, has 180 day UV exposure rating and a 30-year warranty. Premium HT meets ASTM D1970, Florida Building Code 11842, and is Miami-Dade County approved. More information online.

www.mfmbp.com

Titanium Synthetic Roof



Titanium Synthetic Underlayment. The premium choice for protection that lasts. Contractors trust Titanium Synthetic Underlayment for roofing projects that demand performance. Sure-Foot Technology creates a safer nodular walking surface that resists tearing and keeps working to help prevent moisture damage and cracking under tough conditions. Choose one of the most preferred premium synthetic underlayment brands—and the ideal choice for asphalt and metal roofing systems. Discover all the benefits of premium synthetic underlayment.

www.choosetitanium.com

UPCOMING ISSUES FRAME BUILDING NEWS

JANUARY 2020

- **Cover Story:** State of the Industry
- **Product Profiles:**
Frame Building Expo Exhibitors
- **Advertising Deadline:**
November 26, 2019



SUBSCRIBE:

www.constructionmagnet.com/subscribe
or see the subscription card in this issue

ADVERTISING:

Gary Reichert
gary@shieldwallmedia.com • 715-252-6360

EDITORIAL:

Karen Knapstein
karen@shieldwallmedia.com • 715-598-4004

RoofTopGuard SA



RoofTopGuard SA Ice & Water protector is our premium self-adhering synthetic based, high-temperature roofing underlayment. Its 59" width gives the contractor quicker coverage. Can be installed as low as 15 degrees Fahrenheit. The 5" selvage edge is ideal for valleys. RoofTopGuard SA Ice & Water protector can be used under all roof claddings, weighing only 56 lbs.

www.uspunderlayment.com

Sharkskin



Sharkskin—The Ultimate Roof Underlayment. The Sharkskin line of products is designed to ensure that quality roof installations are not compromised by inferior underlayment products. The state of the art in underlayment is found in Sharkskin, which is the only patented roof underlayment on the market. Sharkskin is 100 percent polypropylene, which gives it the following advantages over competitive products and asphalt felts. Sharkskin Ultra and Sharkskin UltraSA are Poly Foam Approved. Sharkskin Ultra Radiant was developed to exceed California Energy Code Title 24 Standards.

www.sharkskin.us

VENTILATION

MWI Components



YOU want a metal roof that lasts longer; MWI wants to help! Adequate roof ventilation and uniform airflow are crucial for proper maintenance of your metal roof. The Ultra-X, breathable, double-glue closure strips are engineered to mold around and seal against the panel profile. This form-fitting product removes any leak path into the ridge area caused by a poor-fitting closure--eliminating wind-driven rain problems! For more info on the Ultra-X visit our website!

www.mwicomponents.com

Marco Industries



As North America's leading ventilation manufacturer, Marco Industries offers superior roof ventilation your way, with products tailored to fit your specific performance requirements and budget. Ventilation products feature an exclusive nonwoven polyester material that delivers extreme durability and breathe to help prevent moisture absorption. All offer a 40-year limited warranty, easy one-person installations, and two full beads of M63, Marco's proprietary adhesive for superior hold.

www.marcoindustries.com

Plyco Corporation



Plyco manufactures and distributes a variety of ventilation products designed to meet most airflow requirements. The MWE-100 is a low profile unit, 10 feet in length with 12 square inches of free air space per lineal foot. The MW100-25 has a higher profile than the MWE and is open at the top. The ventilator has an internal diverter to direct rain off to the side and out onto the roof. The MW100-35 has the same design as the 25 series with increased free air space of 36 square inches per lineal foot. The FMW100-35 is of the same design as the 35 series but the diverter is made from translucent fiberglass to allow light into the building ridge while keeping the rain out.

www.plyco.com

Ventco Inc.



ProfileVent is a single-layer ridge vent on a roll. It's a strong, durable modified polyester, non-woven, non-wicking fiber-based matting, designed specifically for metal roofs. ProfileVent is specifically cut to fit more than 50 standing seam and metal screw-down roofing panels, more than any other ventilation system manufacturer. After 20 years and more than 1,000,000 installations, the company is still waiting for its first callback. ProfileVent is Class A Fire Rated. It will not burn.

www.profilevent.com

ST Fastening Systems



ST Fastening Systems supplies its MultiVent and MultiVent10 closures for those applications requiring airflow on metal roofs. Open cell foam MultiVent, 3 feet in length, and woven polyester MultiVent10, 10 feet in length, allows as much as 98 percent free airflow through the material. However, it prevents wind-driven rain from penetrating the material when compressed. The designs are universal for both, with adhesive applied for easy field installation. MultiVent can be used on angled roof applications and MultiVent10 for ridge cap applications.

www.stfasteningsystems.com

CONDENSATION CONTROL

Filc USA / Dr!pStop

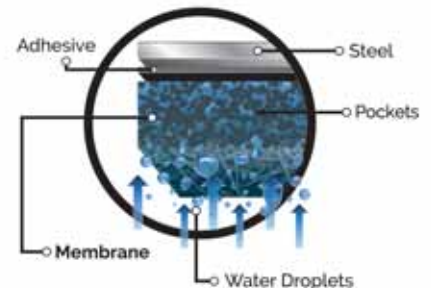

DripStop from Filc USA helps fight condensation without insulation. DripStop traps and holds condensation as it forms until it evaporates back into the air. It arrives at the job site already installed on the steel; saving time and money by eliminating one step of the building process. In addition, DripStop provides a significant layer of protection against corrosion, particularly in animal confinement.

www.dripstop.com



INDEX OF ADVERTISERS/CLASSIFIEDS

Company	Page #
AB Martin	32
Ace Clamp	CVR
Advanced Architectural	6
Bradbury Group, The	42
Building Products Development	32
Dr!pstop - FILC	5
Dynamic Fastener	CVR, 9
East Coast Fasteners	10
Edco Products	CVR
EPDM	8
Graber Post Buildings, Inc.	60
Hershey's Metal Meister	42
Keymark Industries	51
Kirsch Building Products - Sharkskin	13
Leland Industries Inc.	CVR, 17
Maple River Machine	51
Marion Manufacturing	42
Metal Rollforming Systems	39
MFM Building Products	12
MWI Components	39
Nationwide Protective Coatings	36
Paint Valley Parts	53
Petersen Aluminum	7
Raytec Manufacturing	15
rFoil Insulation Products - Covertch	20
Roll Former Corporation	26
Snap Z	53
ST Fastening Systems	19
Star One Products	51
United Steel Supply	11
Ventco	2, 51

AN EXCLUSIVE OFFER ONLY TO OUR ADVERTISERS!

GET YOUR PRODUCT FEATURED

Your product, including a photo and description, will be viewed by an audience of industry professionals in print, email broadcasts and on our website.



**For more information contact:
Gary Reichert at gary@shieldwallmedia.com
715-252-6360**

ROLL FORMERS



- Automation Systems
- Metal Construction Rollformers
- Coil Processing
- Forming & Fabrication
- Recondition Existing Machines

WE ADD THE VALUE TO METAL

1-888-865-8740 www.marionmanufacturing.com



**We Build Machines.
We Sell Solutions.**

- | | |
|-------------------|-----------------------|
| Panel Lines | Portable Roll Formers |
| Purlin Lines | Insulated Panel Lines |
| Control Retrofits | Standing Seam Lines |
| Hydraulic Folders | Garage Door Lines |
| Trim Roll Formers | Slit & Recoil Lines |



www.bradburygroup.com 620.345.6394

Your Trim Shop Suite

Transform your coils into satisfied customers!



Variobend USA double folder



Variobend USA single folder



NEW! Slinet,
The next generation in coil processing.



INFO@HERSHEYSMM.COM
TOLL FREE: (877) 289-3030
420 PROGRESS DR MATTOON, IL 61938



Speed. Accuracy. Service.

Don't just bend trim- Variobend it! Call today!

Comparison of Retrofit Systems Over Existing Metal Roofs

By Brian Gardiner FRCl, RRC, CCS
BMG Enterprises, LLC

The following white paper was written for the Metal Building Manufacturers Association and reprinted with their permission.

The goal of this paper is to compare two commonly used methods of retrofitting existing metal roofs and illustrate important design considerations that frequently apply to candidate buildings. As this is a limited review, not all considerations will apply and additional items not addressed, such as the potential for condensation, can prove important to evaluate for a successful retrofit.

Why Retrofit?

Metal roofs have been documented to perform well and have a long service life. However, when an existing metal roof does reach the end of its service life, or is experiencing problems, it can either be repaired, reroofed, or retrofitted. Retrofitting (aka recovering) has many advantages over reroofing, including:

- Original roof provides temporary building interior protection during new roof installation
- Allows for building operations to continue
- Reduces landfill waste
- Reuses existing insulation and allows adding more insulation over the existing roof
- Provides a safer work surface than exposed existing secondary structural members
- Reduced cost

What are the Retrofit Options?

Typically, a compact (low-profile), lightweight (less than 3 pounds per square foot) retrofit solution is recommended for metal building systems, as the original structure may have been optimally designed using a lightweight metal roof. The existing building's structure may require enhancement to meet the current building code and to function properly for the selected retrofit roof system. Two common retrofit options that are the subject of this paper are:

Metal over Metal: Usually another lightweight metal roof is installed over the existing metal roof [Figure 1]. Metal roof retrofits do not typically rely on the existing metal roof to function as a structural deck for support and attachment of the new metal roof system.

Single-Ply over Metal: Single-ply roof systems are also lightweight and utilized for retrofits over existing metal roofs

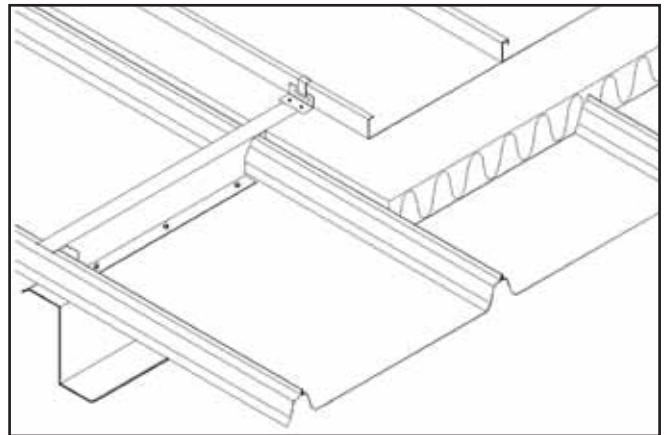

1. Example of a metal over metal retrofit assembly.

[Figure 2]. Many single-ply membrane roofs rely on the existing metal roof to function as a structural deck for support and attachment of the roof system, including board insulation, as well as for support of live, snow, and wind loads, and for providing stability to the roof support members.

What are the Building Code Requirements?

The International Building Code (IBC) and the International

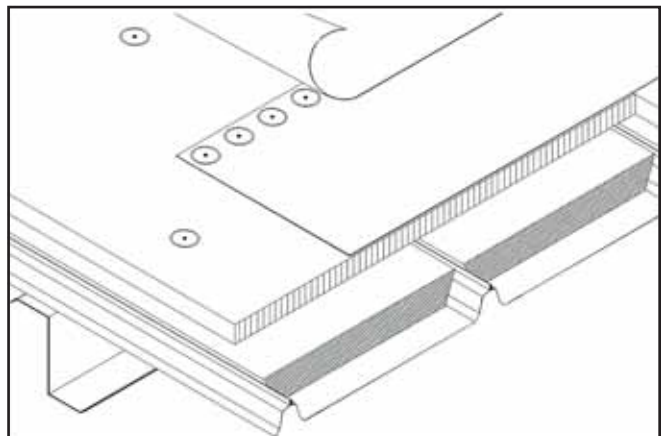

2. Example of a single-ply over metal retrofit assembly.

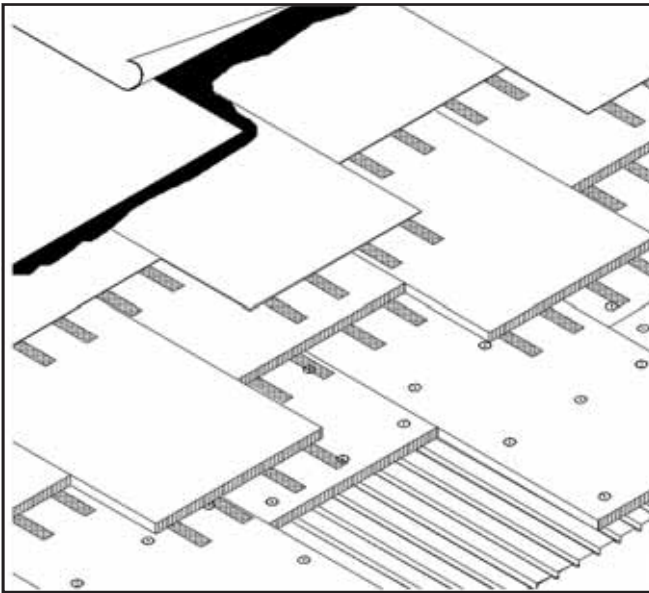

4. Example of steel deck and insulated single-ply roof.

tate strengthening or stiffening the existing support structure, because design loads in the later codes may have increased from the original design requirements.

Secondary Structural Member Deflection

The 2015 IBC Table 1604.3 'Footnote a' stipulates a live load deflection limit of $L/150$ for secondary roof structural members that support only "formed metal sheeted roofing," whereas the deflection limit when supporting a non-metal sheeted roof such as a single-ply roof is $L/180$ [Figure 5]. IBC deflection limits under snow loading and wind loading are identical for the two retrofit systems. Cold-formed steel purlins, often used as

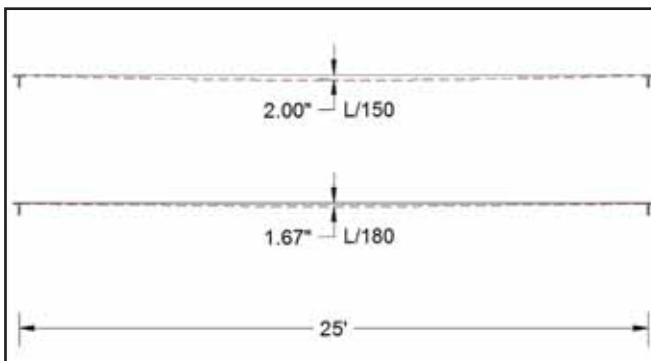

5. Secondary structural member deflection limits at a 25-foot span.

secondary structural members for metal buildings, are not cambered.

The difference in deflection limits could require that the secondary structural members need additional stiffening for code compliance when a single-ply roof is used in a retrofit.

It is recommended that a licensed professional engineer prac-

ticing structural engineering with knowledge of metal buildings evaluate the existing structural system to ensure it is adequate for current building codes and to support the anticipated loads imposed by the retrofit roof system.

Existing Metal Roof Properties

Structural metal roofing is not the same as structural metal decking or steel roof deck. According to the IBC, structural metal roofing is where the metal roof panel functions as the roof deck, providing support for loads, and as a roof covering, providing weather protection. Steel roof deck, according to the Steel Deck Institute (SDI), is defined as steel deck panels used in a structural manner as a base for construction and supporting the roof insulation and membrane.

A single-ply roof system in new construction is designed to be integral with structural metal decking. Using an existing metal roof as the structural support system in a single-ply retro-

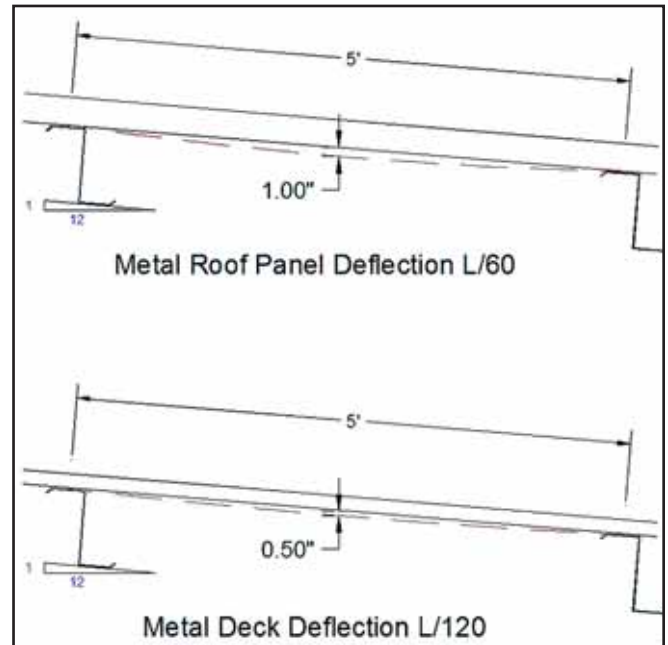

6. Metal roof and metal decking deflection comparisons.

fit assembly changes many of the underlying assumptions and characteristics. For example, most of the wind uplift and fire ratings for single-ply roof systems are based on a 22 gauge, or thicker, steel deck. Steel deck profiles are typically thicker and more rigid than most metal roofs, especially standing-seam panels, which affect the strength and stiffness of the total assembly.

Existing metal roofs are typically 24 gauge, or thinner, steel and were not originally intended to perform as a structural deck for a single-ply roof system. The Steel Deck Institute's ANSI/SDI RD-2010 Standard for Steel Roof Deck has a total load deflection limit for steel roof deck at $L/120$, whereas IBC Table 1604.3 'Footnote a' stipulates a total load deflection limit of $L/60$ for structural metal roofing [Figure 6].

RETROFIT ROOFING

Single-ply roof manufacturers may also have minimum requirements for roof deck properties, depending on how the roof insulation and roof membrane are attached. Roof insulation or single-ply membranes that are adhered, rather than mechanically-attached, are more sensitive to excessive deflection. Therefore, the existing metal roof properties can be substantially different from the typical steel deck used with single-ply roofing. Less incompatibility exists between a metal over metal retrofit since the new metal roof has the same deflection limits and the load path is directly through to the secondary structural members.

It is recommended to consult with the local building official (authority having jurisdiction), a licensed professional engineer practicing structural engineering, and the single-ply roof manufacturer to determine if the existing building's metal roof is adequate to perform as a structural deck for single-ply or other similar retrofit systems.

Ponding Water

The 2015 IBC Table 1604.3 states in 'Footnote e', "The above deflections do not ensure against ponding. Roofs that do not have sufficient slope or camber to assure adequate drainage shall be investigated for ponding."

Most metal buildings with an existing metal roof panel at deflection limit of $L/60$ are sloped sufficiently to prevent ponding water between purlins. Ribbed metal roof panels control rainwater flow and do not allow lateral water movement to purlin mid-span locations where water ponding could progress into a significant problem. As a result, the metal building structural design may have been based on the assumption of a uniform load condition, especially in areas where little, or no, snow loads are anticipated.

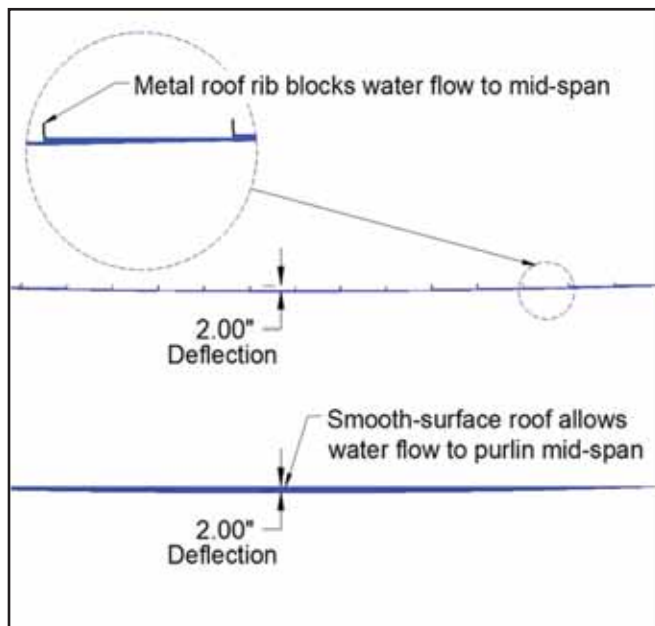

7. Comparison of water flow to purlin mid-span.

A smooth-surfaced single-ply roof, on the other hand, does not control lateral water migration [Figure 7]. In addition, a mechanically-attached single-ply that billows or flutters during wind events may cause an unbalanced load due to water displacement. Unbalanced loads may occur when changing from a ribbed panel to a smooth-surfaced single-ply roof.

Building owners may add additional auxiliary, or collateral, loads to metal building secondary framing from the building interior non-uniformly, resulting in unanticipated excessive deflection due to unbalanced load that may deform adjacent existing purlins upward, sloping towards the excessive deflection [Figure 8].

Deflection resulting in ponding water could be especially troublesome when an existing concealed gutter at a rise wall is retrofitted with either roof drains, or scuppers, that require a head of water on the roof surface to achieve the designed flow

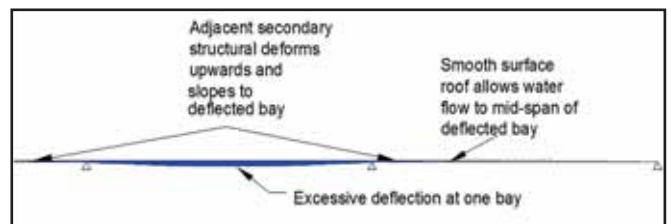

8. Excessive deflection in one bay may result in uplift of secondary structural on adjacent bays.

rate [Figure 9].

Ice and snow melt water could move laterally to the purlin mid-span on a smooth surfaced roof and pond due to differential thaw rates and be restricted from flowing off the roof by ice dams.

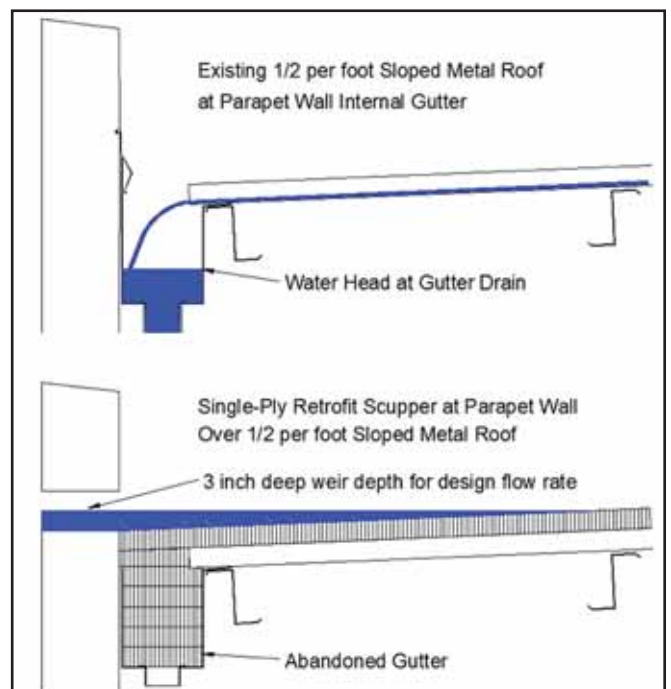

9. Concealed gutters are often covered in retrofit single-ply roofs.

16TH ANNUAL METAL OF HONOR AWARDS

Vote & Be Heard!

TAKE A MINUTE TO SUBMIT YOUR VOTE TODAY.



In April, *Metal Roofing Magazine* will present its **Metal of Honor Awards** for the 16th time. Help us determine the names of suppliers who do the best job of providing you with all of the services and products you need to run your business successfully.

CRITERIA TO CONSIDER WHEN MAKING YOUR CHOICES INCLUDE:

- Quality of customer service
- On-time delivery
- Within budget
- Product quality
- Warranty procedures
- No surprises

SELECT UP TO THREE SUPPLIERS

1. _____
2. _____
3. _____

PREVIOUS WINNERS (*Choose from these or nominate someone new*)

A.B. Martin Roofing Supply
ABC Supply Co.
AceClamp
AkzoNobel
Berridge Manufacturing
D.I. Roof Seamers
Drexel Metals
Dura Coat
Dynamic Fastener
East Coast Fasteners
EDCO Products
Englert
Everlast Metals
Fabral
Fall Protection Distributors

Isaiah Industries
Leland Industries
Logan Stampings
Malco Products
Maze Nails
MBCI
McElroy Metal
Metal Plus
Metal Sales Manufacturing Corp.
MFM Building Products
Morin
MWI Components
New Tech Machinery
Owens Corning

Petersen Aluminum
PPG Industries
RapidMaterials
Roof Hugger
S-5!
Sheffield Metals
Sherwin-Williams
Snap-Z
Sno Gem
ST Fastening Systems
Swenson Shear
Triangle Fastener Corp.
Ventco
Zimmerman Metals

Please return this form by December 31, 2019

Send to:
Sharon Thatcher at sharon@shieldwallmedia.com

Or mail to:
Shield Wall Media • P. O. Box 255 • Iola, WI 54945

RETROFIT ROOFING

The 2015 IEBC 701.2 states: “Conformance. An existing building or portion thereof shall not be altered such that the building becomes less safe than its *existing condition*.” Installing a smooth surfaced roof that results in an unbalanced load condition could be construed as less safe than the original ribbed metal roof that prevented lateral water flow to the purlin mid-span. There are documented failures because of this issue.¹

It is recommended that a review of the building structure, the interior imposed loads, and drainage provisions be performed by licensed professional engineer(s) for unbalanced loads and potential water accumulation on a single-ply retrofit roof that may exceed the existing structural capacity.

Retrofit Roof Fastening

The capacity of the new metal roof panel and the existing metal building purlin thickness and spacing will usually dictate the spacing of the retrofit roof attachment.

IBC references ASCE 7, *Minimum Design Loads for Buildings and Other Structures*, for wind load design. Design wind loads vary due to building height, geographic location, enclosed vs. partially enclosed, parapet height and other factors. Roofs have

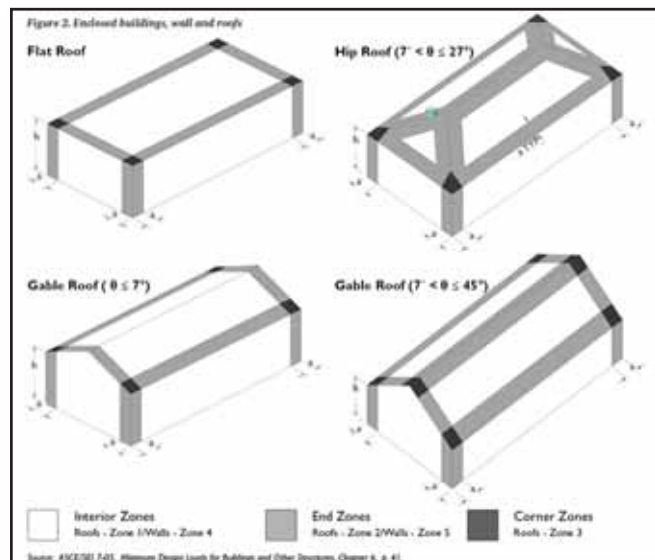

10. Wind uplift zones on varying roof slopes and configurations.

greater wind pressures in corner and edge zones. For steeper slope roofs, there are additional areas of greater wind pressures along the ridge [Figure 10]. As previously discussed, the latest code requirements may be substantially different, especially for wind loads, which have changed significantly over the past few decades.

Compact metal roof retrofits frequently incorporate secondary steel members that are placed directly over the existing metal roof and are easily centered over the underlying purlins [Figure 11]. These additional structural members placed direct-

¹ “Why You Should Think Twice About Putting a Single-Ply Roof on a Metal Building,” by Smith and Wolfe, RCI Interface, November 30, 2016.

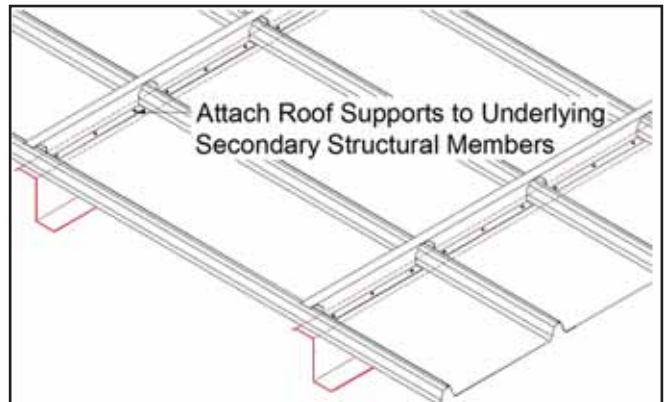

11. New roof supports attached through existing roof.

ly over the existing roof purlins may have the added advantage of increasing the load resistance and other performance characteristics. If properly accounted for in design and/or testing, this added strength can help offset increased loads when more recent codes govern the retrofit.

Single-ply roof systems typically have board insulation in-between the metal roof ribs and one, or more, layer(s) of insulation, or coverboard, on top of the first layer, which typically do not add structural capacity to the roof [Figure 12].

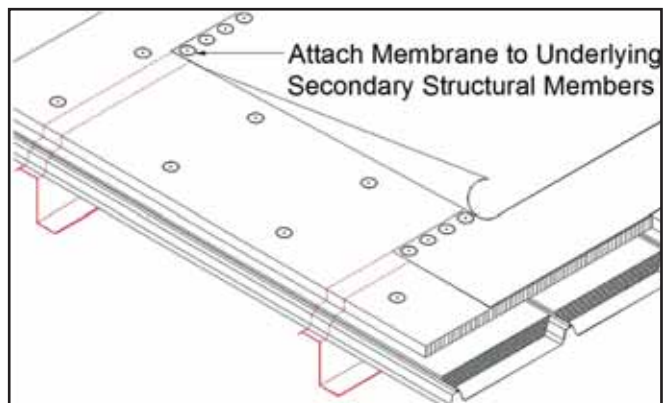

12. Single-ply roof fastening to underlying secondary members.

Most existing wind uplift ratings for membrane roofs are based on a 22 gauge, or thicker, steel deck with a 33 ksi yield strength. Some mechanically-fastened roof designs may require an 80 ksi deck yield strength instead of the 50 ksi yield strength often used for structural metal roofs in metal buildings. Most mechanically-attached single-ply roofs are required to be attached to underlying existing purlins [Figure 12] because the existing roof was not intended to support these concentrated loads.

Mechanically-attached single-ply roof membranes are more difficult to attach to existing secondary structural members than metal over metal retrofits, as purlins are concealed below the insulation layers. This can become a significant issue in ensuring that the membrane is attached correctly during con-

struction [Figure 12].

Metal building roofs are designed based on certain assumptions with regard to the load path and resisting the code specified loads. For a retrofit scenario using a single-ply membrane roof, not only is load path and strength/stiffness of the metal substrate different than typically assumed, but the loads are typically higher if compliance with a more recent code is required. Designers must develop an enhancement solution where existing purlins below the existing metal roof are spaced too far apart to achieve code compliance. Existing secondary structural members may require reinforcement at purlin laps and other structural modifications. One method to enhance an existing structure is to add secondary structural members underneath the existing metal roof. Unfortunately, adding these new members underneath the existing roof is expensive and disruptive to building operations.

Single-ply membrane retrofits are either mechanically-fastened or adhered to the existing structure. For an FM Global insured project, or a project that is required to meet FM Global recommendations by reference, the 2016 FM Global Data Sheet 1-31 may apply. Data Sheet 1-31, Section 2.2.4 indicates that only mechanically-fastened roofs that are attached into secondary structural members are permitted. This is presumably due to unknowns regarding the remaining structural capacity of the existing metal roof that will serve as a roof deck. Data Sheet 1-31, Section 3.1.3 recommends increasing insulation board fastening by 50 percent when attaching insulation board into less than a 22 gauge deck. Data Sheet 1-31, Section 3.1.4 recommends the single-ply membrane fastener density be increased by decreasing the space between fasteners where additional rows of fasteners are not practical due to the lack of secondary structural members. Decreasing fastener spacing will work to a certain point, but may not be sufficient in certain uplift zones.

It is recommended that a design review be performed of the retrofit roof field, perimeter, and corner zones to ensure that the fastening of the roof system is code compliant and to ensure that the existing structure is suitable to withstand the current required loads. Quality control should be implemented during construction to ensure that single-ply membrane fasteners driven through insulation board layer(s) are properly engaged into secondary structural members.

Drag Load

Drag load is a force that is the component of the gravity load parallel to the sloped roof surface, which has the effect of pulling the metal roof panels down the slope of the roof [Figure 13]. This load is particularly high on steeper slopes and when ice and snow accumulate on the roof.

Drag loads need to be resisted in a roof structure. In a metal roof, drag loads are resisted by mechanical anchorage of the metal roofing panels to the underlying structure. Drag load on roofs may result in purlin roll [Figure 13]. Excessive purlin roll, combined with sufficient gravity loads can result in structural

collapse.

When metal roof retrofits are installed with secondary members placed over and anchored to the existing metal roof system, the secondary members provide the resistance to the drag forces. Existing secondary roof members can be

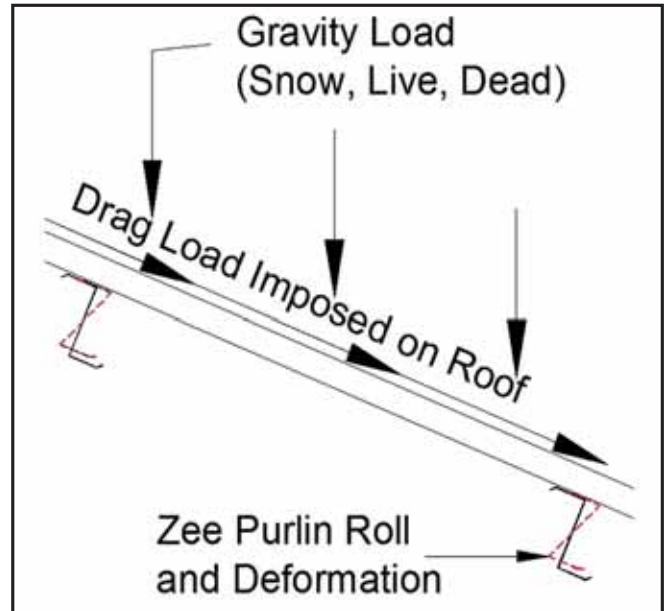

13. Drag load may result in purlin roll.

restrained to resist increased drag loads with added bracing or flexural members. In the case of a single-ply retrofit, the loads are resisted by the lateral loading on long fasteners from the top of the insulating system to the existing purlins. The greater the insulation depth the greater the bending load on the fasteners. The fasteners should be evaluated for bending resistance.

It is recommended that a design review be performed by a licensed professional engineer to determine whether the anticipated system provides the necessary resistance to drag loads.

Fire Rating

Both single-ply and metal retrofit roof systems can incorporate additional insulation between the new and old roofs. Un-faced fiberglass and other high melting point compressible insulation is typically utilized on metal roof retrofits [Figure 14], whereas single-ply roofs incorporate board insulation to provide a suitable bearing surface for a roof membrane [Figure 15]. Board insulation is usually a more efficient insulator than fiberglass batts. Metal panels are typically rated as a Class A roof assembly, according to IBC Section 1505.2, Exception 2, whereas single-ply membranes may or may not have a similar rating. Class A roof assemblies are those that are effective against severe fire test exposure, according to the IBC.

Board insulation used to support single-ply roofs is often expanded polystyrene cut to fit between existing metal roof ribs, combined with a top layer of either more insulation or a

RETROFIT ROOFING

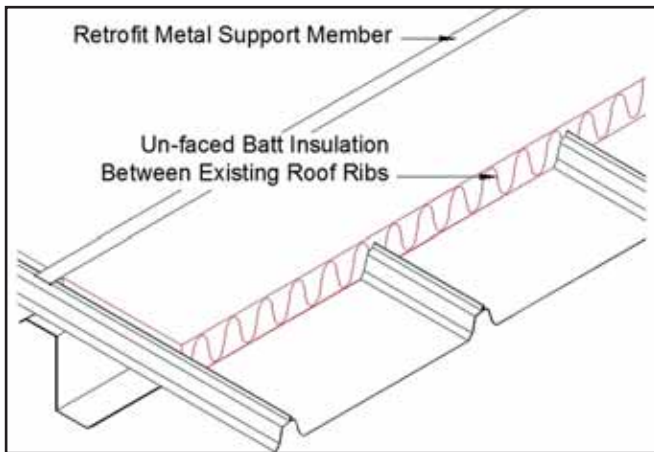

14. One example of metal roof retrofit insulation.

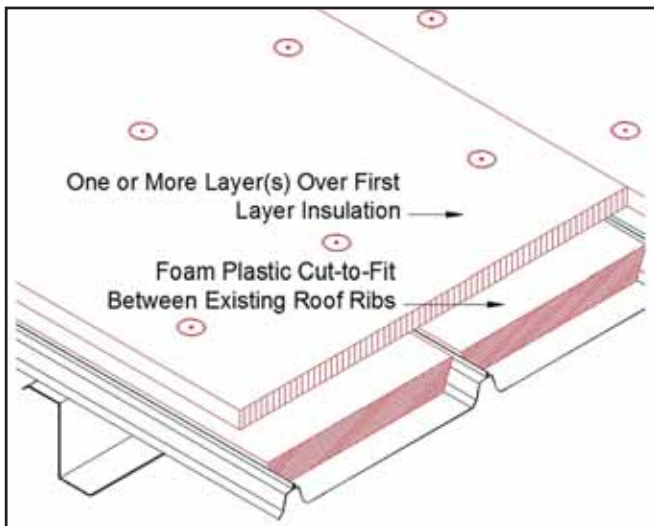

15. One example of single-ply roof retrofit insulation.

coverboard. The 2015 IBC, Section 2603 requires that direct to deck foam plastic insulation meet either UL 1256 or NFPA 276. An FM Global-insured project, or a project that is required to meet FM Global recommendations, would typically be required to meet the more conservative tests described in FM Standard 4880 or NFPA 276 to be an FM Class 1 rated roof assembly.

Un-faced fiberglass will typically pass both tests, whereas board insulation, especially the lower melt point expanded or extruded polystyrene, may not meet either standard. Some foam plastic insulation has been tested and passed the UL 1256 test when placed directly over a 22 gauge, or thicker, metal deck. As stated above, metal roofs have different properties than metal decks and may perform differently in these tests.

It is recommended that the roof designer verify the fire classification both above and below the retrofit roof system for building code and building insurer compliance for the retrofit roof system.

Summary

Retrofit roofs over existing metal roofs have several potential benefits. There are also several design considerations related to the decision to choose a metal, or single-ply roof, especially when retrofitting a metal building. The following recommendations are provided to assist with this decision:

- Engage a licensed professional engineer practicing structural engineering with knowledge of metal buildings to evaluate the following:
 - ✓ Existing roof and structural system to ensure it is adequate for current building codes and to support the anticipated loads imposed by the retrofit roof system.
 - ✓ Retrofit roof field, perimeter, and corner zones to ensure code compliant fastening of the roof system.
 - ✓ Necessary resistance to anticipated drag loads on the retrofit roof system and existing structure.
- The retrofit roof designer should verify the fire classification both above and below the retrofit roof system for building code compliance and building insurer acceptance for the retrofit roof system.

The following additional recommendations are specific to single-ply over metal roof retrofits:

- Engage a licensed professional engineer practicing structural engineering with knowledge of metal buildings to evaluate the unbalanced loads and potential water accumulation on a single-ply retrofit roof with respect to structural capacity and drainage provisions.
- Consult with the local building official, a licensed professional engineer practicing structural engineering, and the single-ply roof manufacturer to confirm that the existing building's metal roof is adequate to perform as a structural deck for a non-metal sheeted roof.
- Implement quality control during construction to ensure that single-ply membrane fasteners driven through insulation board layer(s) are properly engaged into secondary structural members.

Building owners, and their design professionals and contractors, should evaluate retrofit roof solutions for their project to determine what is the most prudent choice. **MR**

COMING FEBRUARY 2020

Garage, Carport & Shed Builder Magazine
is the new industry resource for ideas, information and best practices for the manufacturers and contractors who build Garages, Carports and Sheds.

START YOUR FREE SUBSCRIPTION TODAY!
constructionmagnet.com/subscribe



**SUPERIOR QUALITY
SUPERIOR VALUE
CLASS A FIRE RATED**

Over one million installed over 30 years/zero call backs.

ProfileVent
THE RIDGE VENT CUT TO FIT

www.profilevent.com
Toll Free 833-300-9515
customerservice@ventcoinc.com

**Series
2025 Slitters**
Fast • Accurate • Quiet

Customized to fit your application.
Call for prices and information.

**Maple River
Machine**

WHOLESALE
INQUIRES
WELCOME

231-539-7022 • 1087 Plains Rd • Brutus, MI

smartbuild
systems

THE COMPLETE DESIGN SOFTWARE
FOR POST FRAME BUILDINGS!

SmartBuildSystems.com
303.579.6277

STAR 1
PRODUCTS LLC

Making Felt Application
to Metal, Fast, Easy, & Consistent.

See it in action at the Construction Rollforming Show - Booth 710

888-96-STAR1 (toll free) 231-825-0164 (fax)
231-825-0163 (phone) McBain, MI

AN EXCLUSIVE OFFER ONLY TO OUR ADVERTISERS!
GET YOUR PRODUCT FEATURED

YOUR PRODUCT, INCLUDING A PHOTO AND DESCRIPTION, WILL BE VIEWED BY AN AUDIENCE OF INDUSTRY PROFESSIONALS IN PRINT, EMAIL BROADCASTS AND ON OUR WEBSITE.

THERE ARE THREE WAYS TO GET YOUR PRODUCT PROFILE INCLUDED:

- 1** You have purchased an ad (any size) in the same issue that your Product Profile will appear.
- 2** You buy the Product Profile placement and this purchase includes a spot in a group Product Profiles email.
- 3** Your product is new and newsworthy and our readers will find it of value.

If your company meets one of the qualifications listed, you must submit the following information:

- 50-75 word description of your product or product line
- High resolution (300 dpi) photo of your product.
(Sorry: We do not use logos or ads for the Product Profiles.)

**Contact Gary Reichert
for more information at
gary@shieldwallmedia.com
715-252-6360**



New Leader Takes The Reins At METALCON

Original Organizer, Claire Kilcoyne, Retires

For the first time since its beginning, METALCON will be organized under new leadership.

Claire Kilcoyne, the original organizational leader for the major conference and trade show, has retired from her role.

“After 29 years of partnering with the Metal Construction Association, 35 years at PSMJ Resources, and 800,000 miles on the Mass Turnpike, I am hanging up my trade show sneakers,” said Kilcoyne in a press release prior to the 2019 show in October.

Kilcoyne began her career with the parent company, PSMJ Resources, Inc., in 1985 with a focus on trade-show sales.

After four years, she had the opportunity to devote all of her energy into planning METALCON, which was established in 1991. Despite tough economic times then, it was a huge success because of the demand in the metal construction industry for a new and innovative event. This was the beginning of developing partnerships and relationships that have carried METALCON throughout the years.

Now taking the reins is Judy Geller, a seasoned professional with more than 25 years of experience as a strategist, producer, and marketer in the conference and trade-show industry.

Geller began her career as confer-



Metalcon 2019 tradeshow exhibitor

ence manager for the iconic COMDEX Technology trade show, and the Windows World event produced in conjunction with Microsoft Corporation.

Prior to joining PSMJ Resources, Geller was an event consultant for ICD Events. **MR**

Is Your Catalog Available Online? Is Your Catalog In Our Library?

Rural Builder, Metal Roofing Magazine, Frame Building News, and Rollforming Magazine are combining resources to create a CATALOG LIBRARY for our readers.

**Rural
Builder**

**METAL
ROOFING**

**FRAME
BUILDING
NEWS**

**Rollforming
Magazine**



Rural Builder, Metal Roofing Magazine, Frame Building News, Rollforming Magazine, Roofer Express and Builder Express subscribers can find advertisers' catalogs and products literature in one place, online 365 days per year.



Contact us today for more details

Gary Reichert • 715-252-6360 • gary@shieldwallmedia.com

Texas The Top Spot For Hail Claims

The National Insurance Crime Bureau (NICB) has released the most recent three-year analysis of insurance claims associated with hailstorms in the United States, and Texas and Colorado continue to remain at the top of the list.

According to a review of claims data from ISO ClaimSearch, there were a total of 2,891,291 hail loss claims from January 1, 2016 through December 31, 2018.

The top five states for hail loss claims were Texas (811,381); Colorado (395,025); Nebraska (163,336); Missouri (153,403) and Kansas (146,206).

The top five cities for hail loss claims during that period were San Antonio, Texas (75,187); Colorado

Springs, Colorado (67,920); Omaha, Nebraska (52,803); Denver, Colorado (48,357) and Plano, Texas (42,659).

Over the three years covered by this report, May had the highest monthly average for hail loss claims with 203,296. June was next with 178,881. April (164,232); March (153,716) and July (96,947) round out the top five.

Of the five policy types providing hail loss coverage, Personal Property-Homeowners was the most affected with 1,657,663 claims or 57 percent of the three-year total. It was followed by Personal Auto with 898,500 claims and Personal Property – Farm with 149,215 claims. **MR**

ABC Supply Donates to Veteran's Home Rehab

ABC Supply donated siding and roofing materials, plus installation help to transform a Wisconsin veterans home. The remodeled home was featured on the "Military Makeover" TV show Nov. 8, hosted by celebrity Montel Williams.

Homeowner Steve Wojcik served in the armed forces for 20 years, and was given an honorable discharge and medical retirement in 2005 after suffering serious injuries in Iraq. For his service, he has been awarded a Purple Heart, Meritorious Service Medal and National Defense Service Medal. The husband and father of three teenage daughters is now working as a Wisconsin State Trooper and was nominated by a co-worker for "Military Makeover."

The TV episode is available to watch at <https://militarymakeover.tv/>. **MR**



Paint Valley Parts, Ltd.
ROLL FORMING EQUIPMENT

10550 TR. 262 Millersburg, OH. 44654
Phone (330) 674-4003 Fax (330) 674-4035
Email -acu-form@safecommail.com



Ag Panel	Trim Machines
Shears	Perforators
Slitters	Wrappers
Hemmers	Coil Upenders
Decoilers	Rolls and Tables
	Corners
	Ridge Caps
	J-Channels
	Customer Profiles

Manufacturer of metal forming equipment, for

Commercial and residential construction use,

Using D2 tool steel as a standard for our tooling.





THE ULTIMATE STANDING SEAM RIDGE ROOF VENT

Designed to work with T1, T 1/2", T 3/4", 2" standing seam profiles

**Do It Right.
Do It Efficiently.
No More Call Backs.**

US Pat. No. 8,359,767 B2



GET A RIDGE VENT THAT WILL NOT FAIL

Email: info@standingseamroofvent.com
www.standingseamroofvent.com
 (717) 572-0910

project of the

Private Residence, Montgomery, Indiana



The Aesthetics Of Shingle, The Durability of Steel

This rural residence in Montgomery, Indiana, was in need of a roof upgrade. The owner chose a Cottage Shingle from Boral Steel Stone Coated Roofing because its

high-definition two-color blend offers the aesthetics of a shingle roof with the durability of a steel roof. Installation was done by Graber Post Buildings.

Project Overview

Location: Montgomery, Indiana

Building: Private residence

Roofing contractor: Graber Post Buildings

Roofing Panel: Steel stone-coated Cottage Shingle – Timberwood HD from Boral Steel
Photos courtesy of Graber Post Buildings





**2019
METAL
ROOFING**

TOP 10 PRODUCT

Your Vote Counts!

TAKE A MINUTE TO SUBMIT YOUR VOTE TODAY.

Help decide the Top 10 Products of 2019! Below is a list of products for the metal roofing industry displayed in the pages of *Metal Roofing Magazine* throughout 2019. Let us know which ones you liked the most. We'll announce the winners in the February/March 2020 issue.

FROM METAL ROOFING MAGAZINE APRIL ISSUE:

- Berridge Manufacturing Co. Metal Roof & Wall Panel (Cee-Lock; HR-16 Panel; HS and FW-12)
- Dynamic Fastener screws and clamps with Dyna-Coat
- Englert MetalMan gutter machine
- Everlast Metals architectural roofing and wall systems
- MFM Building Products, Premium HT Tile & Metal and Wind & Water Seal underlayments
- Maze Nails STORMGUARD Double Hot-Dipped Galvanized Nails
- Metal Plus Universal Safety Anchor
- Petersen Aluminum Snap-Clad PAC-CLAD
- Sherwin-Williams WeatherXL and Fluropon coil coatings
- Ventco – ProfileVent
- Zimmerman Metals roll-forming machines
- A.B.Martin metal roofing accessories
- East Coast Fasteners Ply-Lo Extreme screw
- Fabral Slim Seam, Grandrib 3 and Stand'N Seam panel
- Logan Stampings clips and accessories
- Roof Hugger retrofit roofing system
- MWI Uni-Vent II, Uni-Vent III and Ridg-Vents
- Rapid Materials rooftop attachments, tools and mounting solutions
- S-5! Metal roof ancilliary attachment solutions
- ST Fastening Systems WoodBinder and SteelBinder fasteners
- Triangle Fasteners specialty fasteners, tools and sealants
- Covertech, rFoil
- Filc USA, DripStop
- Levi's Building Components, FastVent Plus and FloVent
- Marci Industries, Flex-Pro
- Plyco vents
- Roll Former Corporation, Ag Panel Perforator
- Snap-Z Ridge Vents

FROM METAL ROOFING MAGAZINE MAY ISSUE – Idea Book:

- New Tech SSQ II Roof Panel Machine and the MACH II 7”/8” Combo Gutter Machine.
- London Garment Fall Protection Garment System

FROM METAL ROOFING MAGAZINE JUNE/JULY ISSUE:

- Aluminum Shingle Co., Perma Lock aluminum shingles
- ATAS International, metal tiles, shakes & shingles
- Boral Steel - Boral Steel Stone Coated Roofing
- CertainTeed - Matterhorn Metal Roofing
- DECRA Roofing - DECRA Tile and Villa Tile profiles
- EDCO Products – Infnit Roadhouse metal shingles
- The Interlock Group – InterLock roofing system
- Isaiah Industries – interlocking PVDF-coated steel & aluminum shingles
- TAMKO - TAMKO MetalWorks
- Tilor Roofing North America - Concealed Fastening (CF) Shingle
- East Coast Ply-Lo Driller

FROM METAL ROOFING MAGAZINE AUGUST/SEPT. ISSUE:

- Polyglass USA – Polystick MTS Plus underlayment
- Carlisle WIP Products – WIP 300 HT underlayment
- Firestone Building Products – CLAD-GARD SA FR with CoreGard underlayment
- GCP Applied Technologies Grace Ultra underlayment
- Garland Company – R-Mer Seal Self-adhering high-temp underlayment
- Sharkskin Ultimate Roof Underlayment
- Owens Corning – Titanium Synthetic Underlayment
- Underlayment Specialties Plus – RoofTopGuard SA underlayment
- RoofAquaGuard – Vent 3 underlayment
- Levi's Building Components Roloshield 25 and 50
- TAMKO –TW SeamTape

FROM METAL ROOFING MAGAZINE OCT./NOV. ISSUE:

- ST Fastening, Snow Trax snow guard
- Dynamic Fastener, Dyna Guard snow guard
- Ace Clamp, Sno Titan
- Isaiah Industries – Ice Dam Cutter

Please return this form by December 17, 2019

Send to:
Sharon Thatcher at sharon@shieldwallmedia.com

Or mail to:
Shield Wall Media • P. O. Box 255 • Iola, WI 54945

Thank You

to our advertisers
and subscribers
for making
2019 another
successful year.
We couldn't
have done it
without you.

May 2020 bring
you prosperity,
happiness and
good health.

**METAL
ROOFING**
MAGAZINE

Rollforming
Magazine

**Rural
Builder**

**FRAME
BUILDING
NEWS**

**GARAGE • CARPORT • SHED
BUILDER**



1ST ANNUAL

Construction Rollforming Show 2019

DECEMBER 12-13

Duke Energy Convention Center
Calumet

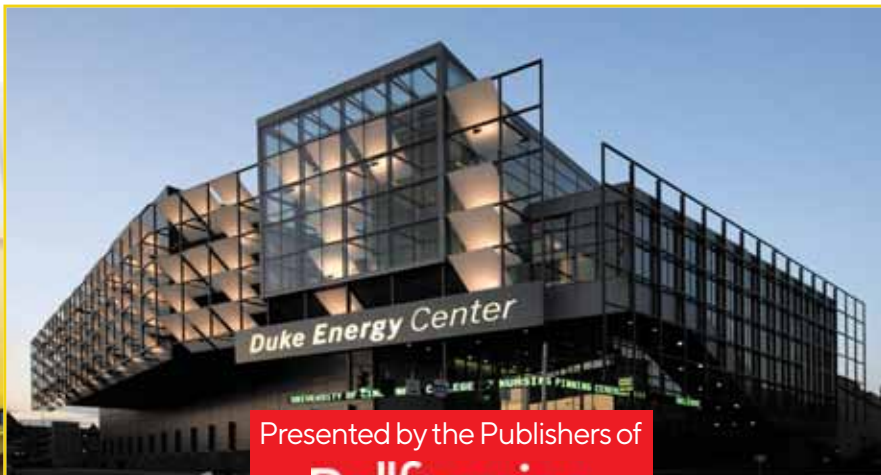

Presented by the Publishers of

Rollforming
Magazine

Online
registration closed.

**REGISTER
AT THE DOOR:**

- Exhibit Floor Entry \$70
- Exhibit Floor + Educational Programming: \$175

FOR MORE SHOW INFO:
bit.ly/CRSShow19

SHOW DETAILS

EXHIBIT FLOOR HOURS:

- Thursday, December 12: 12:30-5:30
- Friday, December 13: 8:30-12:30

EXHIBITORS:

- 15,000 + square feet of roll forming exhibitors
- Roll formers
- Coil suppliers
- Paint and coating manufacturers
- Clips, clamps and components
- Design software
- Efficiency and automation software
- Snow retention, ventilation and moisture control

SPECIAL PRESENTATION:

Friday, December 13

- Industry metrics on roll forming in the construction industry
- Market size, trends and direction
- Growth potential



EDUCATION:

- Inventory control and management
- Improving quality and productivity
- Coil and steel metallurgy and properties
- Paint and coating technology
- Business best practices and development

We are still looking for presenters and additional suggestions for the educational programming. If you would like to be considered as a possible presenter, or have a suggestion for a topic, please contact Gary Reichert. We value your input and suggestions.

EXHIBITORS

COMPANY	BOOTH #	COMPANY	BOOTH #	COMPANY	BOOTH #
3GM/Mac Metal	416	Dynamic Fastener	327	Palram Americas	202
AB Martin Roofing Supply	623	Fasteners Direct	708	Paragon	224
Ace Clamp	414	Flack Global Metals	222	Plyco Corporation	227
Akzo Nobel	523	Graber Post Buildings	428	Presto Tape	2
Albatross LLC	628	Hershey's Metal Meister	501	rFoil Insulation (Covertech)	118
American Producers Supply	411	Hixwood Metals	221	Rollforming Magazine	330
Ameripak	616	Johnson Bros. Roll Forming Co.	412	Royal Crowne Cupola	622
AMS Controls	216	Kloeckner Metals	618	SAMCO Machinery	516
ASC Machine Tool	610	Levi's Building Components	204	Sherwin-Williams Coil Coatings	418
Atlas Bolt & Screw	215	Liberty Steel	524	SmartBuild Systems	515
Beck Automation	422	Marco Industries	624	Snap-Z	101
Bradbury Group	316	Metal Rollforming Systems	201	ST Fastening Systems	528
Cannonball	522	Mill Steel	413	Star One Products LLC	710
Capital Forest Products	621	MWI Components	309	Stoll Metal Works	702
Cidan Machinery	310	NC Automation	312	SWI Machinery	302
County Line Concepts	521	New Tech Machinery	602	United Steel Supply	301
Cross Bridge Marketing	109	Northern Building Components	105	Ventco/Profile Vent	321
Direct Metals	112	Northstar Metals Manufacturing	122	Zimmerman Metals	210
Dr!pstop	209	Onduline/Tuftex	102		
Drexel Metals	110	Paint Valley Parts/Acu-Form	116		

Thank you to our PREMIER Sponsors for promoting the 2019 CONSTRUCTION ROLLFORMING SHOW!



FOR MORE INFORMATION CONTACT GARY REICHERT:
gary@shieldwallmedia.com • 715-252-6360



COIL DIVISION

Mixed Color Loads Available

- 29 & 26 Gauge | Grade 80 & 50
- Color Matched Gutter & Components
- Color Matched Roll-Formed Trim Components
- Custom Slit Widths/ Lengths
- Prime 40 year SMP and 10 year Polyester



**28
Color
Options**



Grabber Post Buildings, Inc.

7716 N. 900 E. | Montgomery, IN | 47558

Grabberpost.com | 800-264-5013